

Wallbox eMH1

Installation manual



Contact

ABL

ABL SURSUM



Bayerische Elektrozubehör GmbH & Co. KG

Albert-Büttner-Straße 11
91207 Lauf an der Pegnitz
Germany

 +49 (0) 9123 188-0
 +49 (0) 9123 188-188

 info@abl.de
 www.ablmobility.de

Customer Service

 +49 (0) 9123 188-0
 service@abl.de
 www.ablmobility.de/de/service/support/



Contents

Contact	II
Additional technical information	IV
Intended use	IV
Information in this document	IV
Safety and user information	5
General	5
Safety information	5
User information	6
Introduction to the Wallbox eMH1	8
Identifying your wallbox	8
Components included with the wallbox	8
Accessories	9
Mechanical and electrical installation	11
Installation site requirements	11
Tools and accessories required	12
Preparing the installation site	13
Preparing and fixing the wallbox in place	14
Electrical connection of the wallbox	15
Commissioning the wallbox	16
Affixing the label in accordance with DIN EN 17186-2019	18
Configuration via software	20
Data cable connection with the computer	20
Charging procedure	22
Error resolution and maintenance	24
Identifying errors	24
General operational malfunctions	28
Checking the internal RCCB	29
Taking the Wallbox eMH1 out of operation	30
Maintenance	30
Appendix	31
Technical specifications	31
Standards and guidelines	32
Trademarks	33
Dimensions	33
Definitions	33
Copyright and disclaimer	34
CE certification and declaration of compliance	34
Drilling template	35
Disposal advice	35

Additional technical information

Additional technical information is required to install your wallbox on one of the separately available mounting poles, as well as regarding further accessories. It is contained in separate documents.

In addition, the technical data for your wallbox are collated in product-specific data sheets. You can download these documents from the ABL website using the following link:



<https://www.ablmobility.de/en/service/downloads.php>

NOTE

Displaying the additional information on a computer, tablet or smartphone

Additional technical information is made available in the Portable Document Format (PDF).

- To display PDF files, you need the free Adobe Acrobat Reader or comparable software.

You can find further information about our product range, as well as about separately available accessory components on our website at www.ablmobility.de. Please visit:

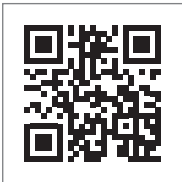

<https://www.ablmobility.de>

Intended use

The Wallbox eMH1 is intended for charging your electric vehicle according to IEC 61851-1 Mode 3, and is available in a range of versions with different charging capacities, and featuring either a fixed charging cable with Type 2 charging connector or an integrated Type 2 charging socket for connecting a range of separately available charging cables.

Information in this document

This document explains how to install, configure and commission the Wallbox eMH1: It is recommended that all working steps described in this document are carried out by a qualified specialist electrical contractor only.

	User	Specialist electrical contractor
Installation manual (this document)	✗	✓
Additional technical information		
▪ Data sheets	✓	✓
▪ Operating manual	✓	✓
▪ ABL Configuration Software manual	✗	✓

Safety and user information

General

This manual describes all working steps required to install and/or operate the product it concerns.

Certain sections of this manual are specially formatted for quick and easy reference.

- Descriptions listing equally valid options are indicated by bullet points.
- 1 Descriptions listing operating steps are numbered in chronological order.



DANGER!

Indicates life-threatening electrical voltages

Sections marked with this symbol indicate electrical voltages that present a danger of loss of life or grievous bodily injury.

- Actions marked with this symbol must not be carried out under any circumstances.



WARNING!

Indicates important actions and further hazards

Sections marked with this symbol indicate further hazards that may result in damage to the product or to other connected components.

- Actions marked with this symbol must be carried out with special care.



NOTE

Indicates important information for operation or installation

Sections marked with this symbol indicate further important information and features necessary for successful operation.

- Actions marked with this symbol should be carried out as required.
- Passages marked with this symbol contain valuable additional information.

Safety information

The safety notices serve to ensure the proper and safe installation, as well as subsequent safe operation of the device.



DANGER!

Violation of the safety information

Disregard of or actions contrary to the safety information and instructions contained in this manual may lead to electric shock, fire, severe injury and/or death.

Please pay attention to the following points:

- Please read this manual carefully.
- Heed all warnings and follow all instructions.
- Keep this manual in a safe place where it can be accessed at all times: The contents of this manual, and the safety notices in particular, must be available to all users of the product.
- Only use accessories intended and sold for the product by ABL.
- Only use charging cables that comply with the IEC 61851 standard.
- Do not install this device in close vicinity to running water, water jets or areas subject to flooding.
- The product must not be installed in explosive atmosphere areas (EX areas).

- Mechanical installation should be carried out by qualified specialist personnel.
- Electrical installation and testing must be carried out with reference to local rules by a qualified specialist electrical contractor, who, on the basis of their specialist training and experience, as well as their knowledge of the relevant standards, is able to assess and carry out the working steps described in this manual and recognise potential hazards.

**WARNING!****Notification or approval requirement for charging stations**

Please note that electrical grid operators, energy suppliers or national regulations may require notification of or approval for the installation or operation of a charging station.

- The product must only be operated after final approval by a qualified specialist electrical contractor.
- In case of installation faults, or malfunctions that can be traced back to faulty installation, always contact the contractor who carried out the installation first.
- The product must not be covered with stickers or other objects or materials.
- No liquids or receptacles containing liquids must be placed on the product.
- Please note that operating a radio transmitter in the immediate vicinity (< 20 cm) of the product may lead to malfunctions.
- This device is not intended to be used by persons (including children) with limited physical, sensory or mental abilities or lack of experience and/or knowledge, unless they are supervised by someone responsible for their safety or have received instructions on how to use the device.
- Children must be supervised so that they do not play with the device.
- Do not under any circumstances make alterations to the product. Any disregard of this instruction represents a safety risk, fundamentally breaches the guarantee provisions, and may void the warranty with immediate effect.
- Malfunctions affecting the safety of persons, connected electric devices or the device itself must be resolved by a qualified specialist electrical contractor.
- Should one of the following malfunctions occur, please contact the specialist electrical contractor who has carried out the installation of your wallbox and accessories:
 - The product housing has been damaged mechanically, or the housing cover has been removed or can no longer be closed.
 - Sufficient protection against splashing water and/or foreign objects is no longer provided.
 - The product does not function properly or has been otherwise damaged.

User information

- Ensure that the rated voltage and rated current of the product comply with the parameters of your local electricity grid and that the rated output is not exceeded during operation.
- Local safety regulations regarding the operation of electrical devices for the country in which you operate the product always apply.
- To disconnect the product completely from the electricity grid, the power supply must be interrupted using the upstream safety switches and fault current protection devices (if present) in the domestic power distribution.
- Never operate the product in a confined space.
- Ensure that the product can be operated without any strain pulling on its components.
- Make sure that the product is always closed and locked when in use. All authorised users must be aware of the 'unlock' position of the key.
- You must under no circumstances make any changes to the housing or the internal wiring of the device: Any disregard of this instruction fundamentally breaches the guarantee provisions and voids the warranty with immediate effect.
- Only have the product repaired by a qualified specialist electrical company.

**WARNING!****Proof of professional qualification**

In order to carry out repairs on or exchange electrical components, proof of completion of an ABL training course may be required: For this purpose, please contact ABL technical support (see "Contact" on page II).

**NOTE****Changes to functions and design features**

Please note that all technical details, specifications and design characteristics of the product may be changed without prior notice.

Introduction to the Wallbox eMH1

The Wallbox eMH1 is available in model variants with different charging outputs, which are optionally equipped with fixed charging cables with Type 2 charging connector, or with an integrated Type 2 charging socket. Further information on technical data are available in the appendix from page IV.

Identifying your wallbox

The model variant of the Wallbox eMH1 can be unambiguously identified on the rating plate located on the inside of the housing cover. Before beginning with installation, open the housing cover and check the rating plate for the information listed below.

The following information is especially relevant:

- Product number
- External power supply

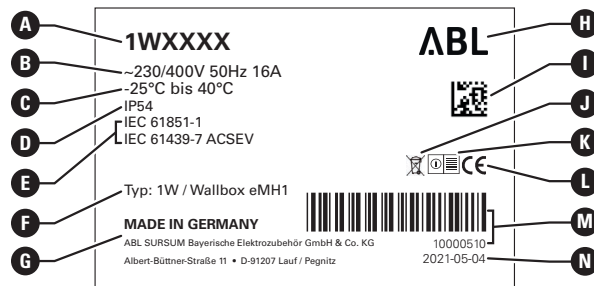
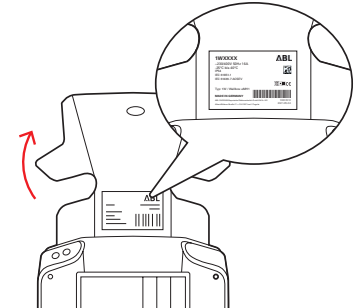

- | | | |
|---|--|-------------------------------------|
| A Product number | F Indication of type/production series (1W or Wallbox eMH1) | K 'Read instructions' advice |
| B Power supply (voltage, frequency, current) | G Country of manufacture and manufacturer | L CE label |
| C Operating temperature | H Manufacturer | M Barcode/serial number |
| D IP rating | I DataMatrix code/product number | N Date printed |
| E Standards | J Disposal advice | |

Components included with the wallbox

The product is delivered including the following components:

- Wallbox eMH1, 1 pc

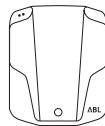

- Safety notices & quick start guide (multilingual), 1 pc



- Drilling template, 1 pc

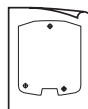

- Key, 2 pcs



- Wall plugs 8 × 40 mm, 3 pcs



- T20 countersunk screw, 5 × 60 mm, 3 pcs



- Label for marking the charge points according to DIN EN 17186-2019, 1 pc
 - For charging station with socket
 - For charging station with cable



NOTE

Checking the components included

Check immediately after unpacking whether all components are included: should any components be missing, please contact the dealer from whom you purchased the wallbox.

Accessories

The following accessories for the Wallbox eMH1 are available separately:

■ POLEMH1

Galvanised sheetmetal mounting pole for the outdoor installation of one Wallbox eMH1 with or without mounting plate, the weather shield WPR12 and the cable holder CABHOLD

$h = 1,647 \text{ mm}$, $w = 285 \text{ mm}$, $d = 180 \text{ mm}$

■ EMH9999

Precast concrete foundation for installing the mounting pole POLEMH1

$h = 650 \text{ mm}$, $w = 430 \text{ mm}$, $d = 190 \text{ mm}$

■ WHEMH10

Mounting plate with cable storage holder for all Wallboxes eMH1

$h = 482 \text{ mm}$, $w = 226 \text{ mm}$, $d = 93 \text{ mm}$

■ 1W0001

Mounting plate with key switch and cable storage holder for all Wallboxes eMH1 with EVCC2

$h = 482 \text{ mm}$, $w = 226 \text{ mm}$, $d = 101 \text{ mm}$

■ WPR12

Weather shield for installation on an exterior wall or the mounting pole POLEMH1

$h = 142 \text{ mm}$, $w = 395 \text{ mm}$, $d = 225 \text{ mm}$

■ CABHOLD

Cable holder with charging plug receptacle for installation on an exterior wall or the mounting poles POLEMH1/2/3

$h = 187 \text{ mm}$, $w = 76 \text{ mm}$, $d = 105 \text{ mm}$

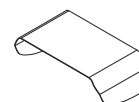
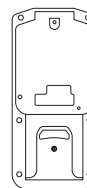
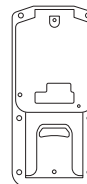
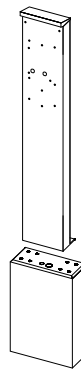

■ **CONF CAB**

Configuration kit for connecting all ABL charging stations to a Windows PC for configuration via specific software applications by ABL

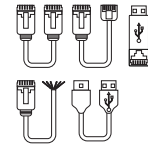

■ **TE001**

Multipurpose measuring device for security checks according to IEC/EN61557, as well as for testing charging stations via the adapter TE002, suitable for TN, TT, and IT protective earthing systems

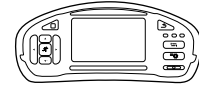

■ **TE002**

EVSE and vehicle simulation adapter according to IEC 61851 for checking the function and electrical safety of charging stations

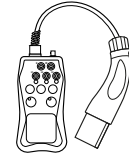

■ **LAK32A3**

Type 2 charging cable according to IEC 62196-2, up to 32 A 240/415 V AC, 3-phase, length ca. 4 m

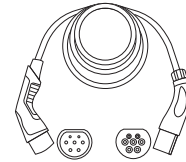

■ **LAKC222**

Type 2 charging cable according to IEC 62196-2, up to 20 A 240/415 V AC, 3-phase, length ca. 7 m

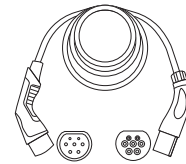

■ **LAKK2K1**

Type 2 to Type 1 adapter cable according to IEC 62196-2, up to 32 A 230 V AC, single phase, length ca. 4 m



You can find further information on **ABL** charging stations and accessories at www.ablmobility.de.



Mechanical and electrical installation

It is recommended to have the entire installation of the wallbox carried out by a qualified specialist electrical contractor.



DANGER!

Dangerous electrical currents

Electrical installation, as well as final testing and certification for operation must be carried out by a qualified specialist electrical contractor, who, on the basis of their specialist training and experience, as well as their knowledge of the relevant standards, is able to assess and carry out the working steps described in this manual and recognise potential hazards.

Installation site requirements

Your wallbox is suitable for outdoor use. Please note, however, that the permissible ambient conditions (see “Technical specifications” on page 31) must be adhered to in order to guarantee the functionality of your wallbox at all times.

- The installation site must be freely accessible.

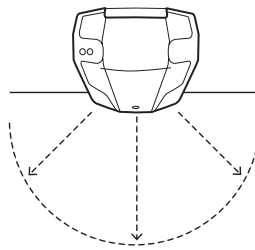

- The mounting surface must be level and solid.

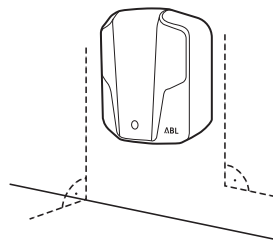

- The mounting surface must measure at least 273 x 222 mm (height x width). Overhangs caused by the charging socket or the stored charging cable are not included in these dimensions.

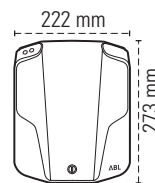

- The installation height should be between 140 and 160 cm (ground to bottom edge of housing).

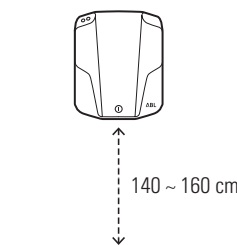

- Minimum distances to other technical installations must be observed.

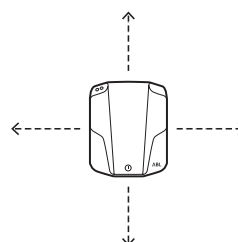

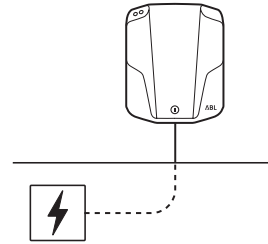

- Ideally, the installation site should provide a ready connection to the electricity grid. Otherwise, a separate power supply cable must be installed.





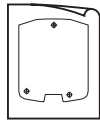





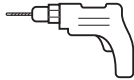



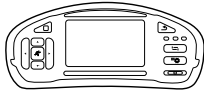

Tools and accessories required

For mechanical installation, you will need the following components included with the wallbox:

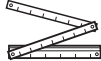
- Drilling template, 1 pc 
- Wall plugs 8 × 40 mm, 3 pcs 
- T20 countersunk screw, 5 × 60 mm, 3 pcs 

In addition, you will need the following tools

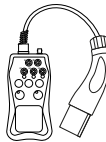
- Electric drill 
- 8 mm Ø drill bit suitable for the respective mounting surface 
- Bit (Torx T20) 
- Screwdriver (Phillips head) 
- Spirit level 
- Hammer 
- Multi-purpose installation tester 
- Voltage tester 
- Scissors 
- Pencil 
- Tape measure 
- Screwdriver (Torx T20) 
- Pliers 
- Utility knife 
- Vehicle simulation adapter 

Preparing the installation site

As a matter of principle, the electrical supply cable in the domestic power distribution must be switched off for the entire duration of mechanical and electrical installation. The connection to the power grid must only be made live for the purpose of commissioning, after electrical installation is complete.



DANGER!

Dangerous electrical currents

Always observe the 5 safety rules:

- 1 Cut power source
- 2 Secure all cut-off devices
- 3 Verify absence of voltage
- 4 Ground and short-circuit
- 5 Cover or bar access to adjacent components under voltage

Proceed as follows:

- 1 Cut crosswise into the marks for the fixing points on the drilling template using the utility knife.
- 2 Use the scissors to cut out the area for the power supply in the lower portion of the drilling template.

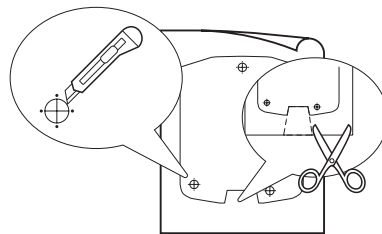

NOTE

Operation on an optional mounting plate

Should you wish to operate the wallbox on a mounting plate (WHEMH10 or 1W0001), you must use the drilling template included with the respective mounting plate.

- 3 Using the spirit level, align the drilling template level and plumb on the mounting surface.
 - The cutout in the lower portion of the drilling template should align with the opening for the power supply cable.

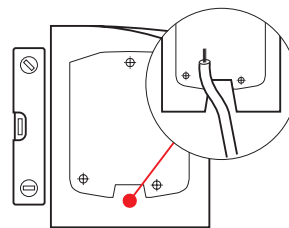

- 4 With the pencil, mark the fixing points in the mounting position.



- 5 Pre-drill the marked fixing points with the electric drill and drill bit.

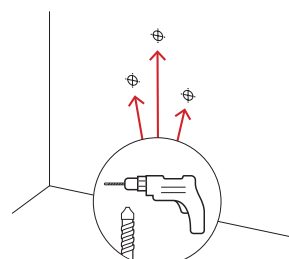

- 6 Drive the wall plugs into the fixing points with the hammer.

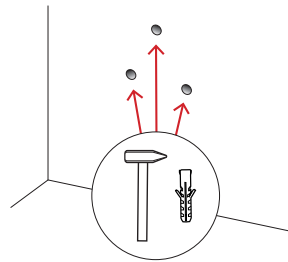

- 7 Insert one of the supplied countersunk screws into the upper fixing point using the electric drill with a suitable bit so that the distance between the screw head and the wall measures 4 mm.

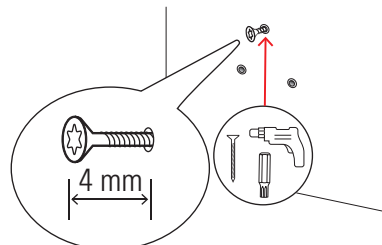

Preparing and fixing the wallbox in place

Continue to prepare the wallbox:

- 8 Open the housing cover of the wallbox using the key supplied and flip it up.

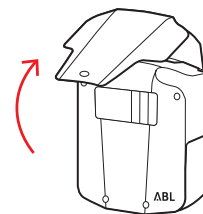

- 9 Loosen the four screws of the upper part of the housing using the Phillips head screwdriver.
- Keep the four screws in a safe place.

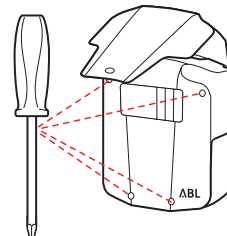

- 10 Remove the upper part of the housing from the housing base.

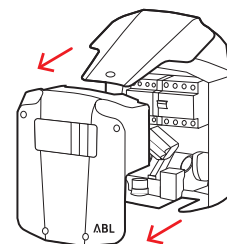

- 11 Remove the rubber grommet at the bottom of the housing base: use the utility knife to cut an opening for the power supply cable into the rubber grommet and then replace it in the housing base.

- If the power supply cable is surface mounted, you must break off the plastic tongue in the lower section of the housing base using the pliers.

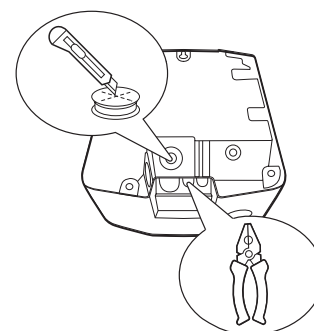

12 Using the screwdriver (Torx T20), loosen the internal strain relief, which is located on the inside of the housing base above the rubber grommet.

13 Insert the supply cable through the rubber grommet into the housing base.

14 Hang the housing base onto the countersunk screw you inserted at the mounting point in **Step 7**.

15 Using the power drill and bit, fix the housing base to the two lower mounting points with the two countersunk screws.

- Select a torque that will not distort the housing base.

16 Using screwdriver (Torx T20), secure the power supply cable in the internal strain relief.

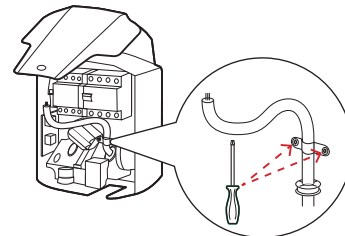
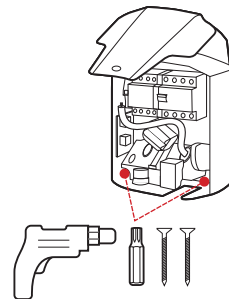
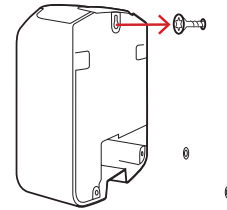
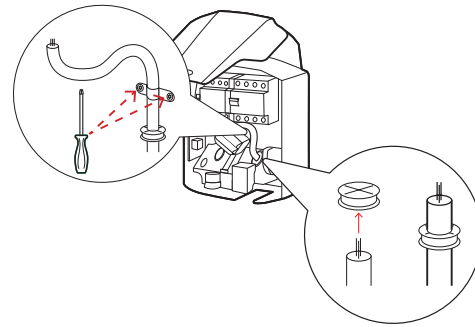

Electrical connection of the wallbox



DANGER!

Dangerous electrical currents

- Electrical connection must be carried out by a qualified specialist electrical contractor!
- Ensure that the power supply cable remains disconnected from the electricity grid.
- Deactivate the RCCB in the wallbox and/or in the domestic power supply.

Proceed as follows to connect the power supply cable inside the wallbox:

1 Cut the supply cable to the required length with the pliers.

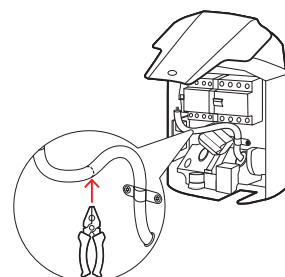

2 Insert the individual conductors of the power supply cable into the respective terminals of the RCCB and tighten them using the Phillips-head screwdriver.

- End ferrules must be fitted on flexible conductors.
- Operate the spring-loaded mechanism of the PE terminal and attach the protective earth conductor.
- Use the connection patterns listed below to allocate the individual conductors.

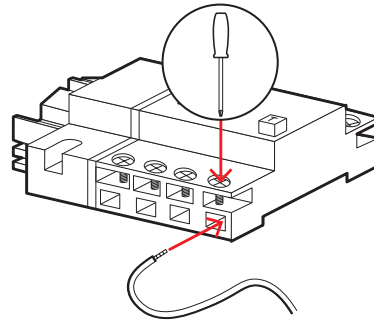

Connection pattern for 1-phase TN system

Designation	Conductor colour	Marks for
Phase 1 current-carrying conductor	Brown	L1
Neutral	Blue	N
Protective earth	Green-Yellow	PE

Connection pattern for 3-phase TN system

Designation	Conductor colour	Marks for
Phase 1 current-carrying conductor	Brown	L1
Phase 2 current-carrying conductor	Black	L2
Phase 3 current-carrying conductor	Grey	L3
Neutral	Blue	N
Protective earth	Green-Yellow	PE



WARNING!

Allocation of wire colours

Please note that the colour-coding convention used above is not internationally standardised.



WARNING!

Checking the connection

Please ensure that the conductors that are pre-fixed to the RCCB terminals remain attached correctly after connecting the power supply cable.

Commissioning the wallbox

To commission the wallbox, the power supply cable must be connected to the electricity grid.



DANGER!

Dangerous electrical currents

The following working steps must be carried out with the utmost care: There is a risk of electric shock if conductive components are touched.

1 Switch on the MCB in the domestic power distribution box.

- As soon as the wallbox is connected to the electricity grid, it will initiate the start-up procedure.
- Both LEDs flash and then turn off.

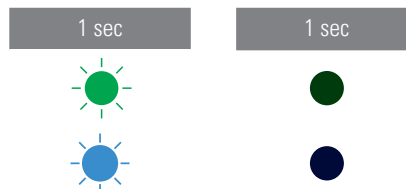
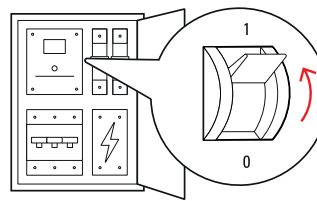

2 Measure the voltage at the RCCB terminals using the voltage tester.

- In single phase installations, the voltage is measured between the phase and neutral conductors.
- In 3-phase systems, all phases are measured against each other (400 V) and all phases are measured against the neutral conductor (230 V).

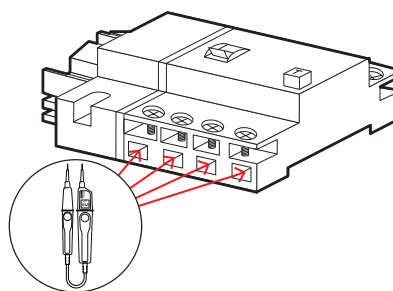

3 Use the installation tester and the vehicle simulation adapter to conduct all other required checks.

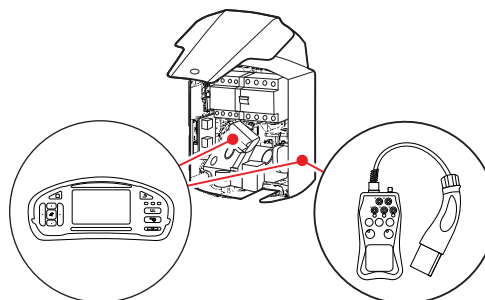

WARNING!

Conducting all necessary checks

Now conduct all locally required checks and testing of the wallbox and its electrical installation. These include the following tests:

- Effectiveness of protective earth conductor connections
- Insulation resistance
- Loop impedance
- Voltage drop
- RCCB tripping current and tripping time
- Rotating field testing

as well as additional tests according to local regulations.

4 Place the upper part of the housing onto the housing base.

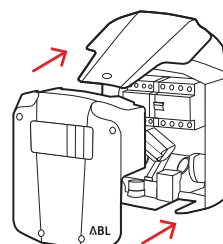

- 5 Fix the upper part of the housing to the housing base using the screws removed in **Step 9**.

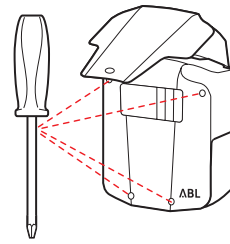

- 6 Switch on the RCCB in the wallbox and/or the domestic power distribution.

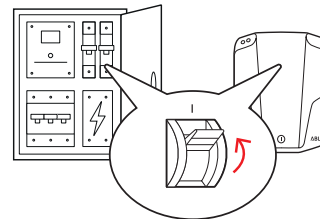

- 7 Now lock the housing cover using the key.

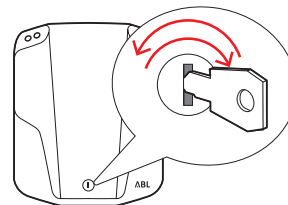

- 8 Use the vehicle simulation adapter to conduct a functional test of the charging function.

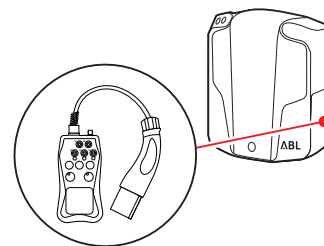

The installation of the Wallbox eMH1 is now complete and the wallbox switches to normal operating mode.

Affixing the label in accordance with DIN EN 17186-2019

In accordance with DIN EN 17186-2019, a graphical indication of the compatibility of vehicles and the charging infrastructure is mandatory for commercial use. Your charging station therefore comes with a sticker which the operator must position near the charge point after the installation has been completed.

Wallbox eMH1 with charging socket

- One sticker with black writing on a white background is supplied for this variant.
- ABL recommends affixing the sticker in the position shown on the right-hand side.

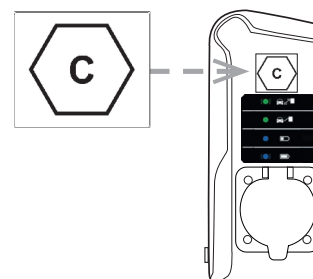

Wallbox eMH1 with charging cable

- One sticker with white writing on a black background is supplied for this variant.
- ABL recommends affixing the sticker in the position shown on the right-hand side.

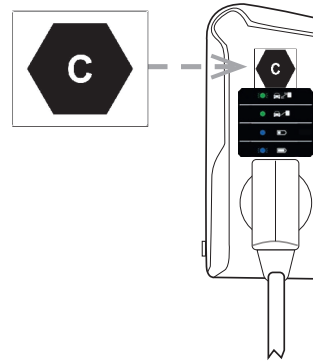

! NOTE

Further information on labelling

- The charging cables optionally available from ABL are marked accordingly by default.
- In the case of purely private use, there is no obligation to affix the sticker to the charging station.
- The sticker can be reordered as an accessory in case of switching from private to commercial use at a later date.

Configuration via software

The Wallbox eMH1 is factory preset for use in private households or similar applications, and is ready for use immediately after mechanical and electrical installation have been completed. However, individual parameters can be adjusted for these kinds of stand-alone applications if required:

- The factory preset charging current can be lowered and reset to its authorised upper limit at a later time.
- **Only relevant for models with a preset charging current of 32 A:** To connect vehicles with a single-phase charging module, phase load unbalance detection can be activated, which limits the charging current and so prevents a phase load unbalance in the grid.

In both cases, the Wallbox eMH1 must be connected to a suitable computer via the configuration kit CONFCAB (see next section). Configuration using the **ABL Configuration Software 1.7** or above is described in a manual, which you can download here:

<https://www.ablmobility.de/en/service/downloads.php>

Data cable connection with the computer

To connect the Wallbox eMH1 to a Windows PC, you will need the configuration kit CONFCAB (separately available accessory), which makes the wallbox's modbus interfaces compatible with the computer's USB port. Using CONFCAB components, any charging station from the Wallbox eMH1 product series can be connected by cable:

- ① USB extension cable
- ② USB to RJ45 adapter
- ③ RJ45 to individual strands patch cable
- ④ RJ45 to RJ12 patch cable
- ⑤ RJ45 to RJ45 patch cable



WARNING!

Data cabling using CONFCAB

Only use the cables and adapters contained in the CONFCAB kit to connect your Wallbox eMH1 to the computer. Otherwise, faultless communication cannot be guaranteed.

Proceed as follows to connect the Wallbox eMH1 with the computer by cable:

Wallbox eMH1 with spring terminals (until mid-2021)

- 1 Remove the upper part of the housing as described in section "Preparing and fixing the wallbox in place" on page 14.
- 2 Connect the patch cable ③ to the spring terminals located on the left hand side of the interior of the wallbox.
- 3 Connect the USB extension cable ① to one of the computer's USB ports.
- 4 Use the USB to RJ45 adapter ② to connect the patch cable ③ to the USB extension cable ①.

The wallbox is now connected to the computer by cable.

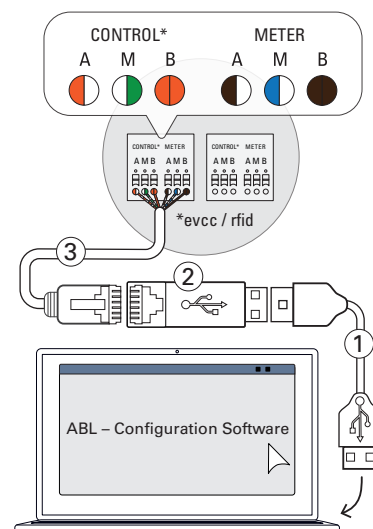

**Wallbox eMH1 with RJ12 interface
(eMH1 Basic and eMH1 models until mid-2021)**

- 1 Remove the upper part of the housing as described in section "Preparing and fixing the wallbox in place" on page 14.
- 2 Connect the patch cable ④ to the RJ12 port located on the left hand side of the interior of the wallbox.
- 3 Connect the USB extension cable ① to one of the computer's USB ports.
- 4 Use the USB to RJ45 adapter ② to connect the patch cable ④ to the USB extension cable ①.

The wallbox is now connected to the computer by cable.

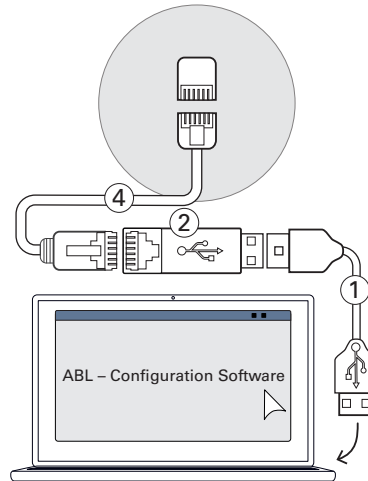

**Wallbox eMH1 with E2I interface
(from mid-2021)**

- 1 Remove the upper part of the housing as described in section "Preparing and fixing the wallbox in place" on page 14.
- 2 Connect the patch cable ⑤ to one of the RJ45 ports located on the left hand side of the interior of the wallbox.
- 3 Connect the USB extension cable ① to one of the computer's USB ports.
- 4 Use the USB to RJ45 adapter ② to connect the patch cable ⑤ to the USB extension cable ①.

The wallbox is now connected to the computer by cable.

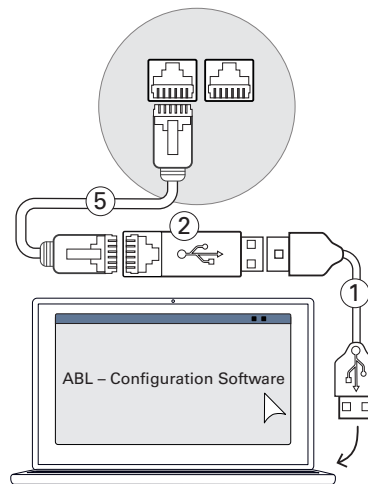

You can now start setting up the wallbox using the **ABL Configuration Software**.

■ **Setting the charging current, activating phase unbalance detection**

Read the section **Configuring a single charging station > Individual settings for the charging station** in the **ABL Configuration Software** manual.

Charging procedure

After installation and configuration, the eMH1 is ready for operation immediately, and can now be used to charge an electric vehicle.

To charge an electric vehicle, proceed as follows:

1 Park your electric vehicle so that its charging inlet can be easily reached with the charging cable's charging connector.

2 Check the LEDs on the wallbox:

- When the wallbox is ready for operation, the green LED will flash every 5 seconds, while the blue LED will be OFF.

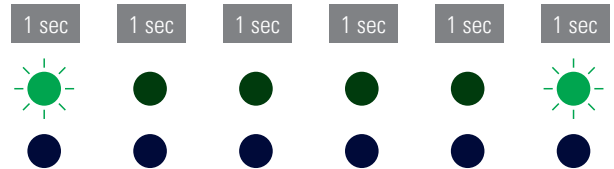

3 Prepare the charging cable of the wallbox and the vehicle's charging inlet.

• **Wallbox with charging cable**

Slightly lift up the charging connector and pull it downwards from its storage compartment. Open the charging inlet at the vehicle and plug in the charging connector.

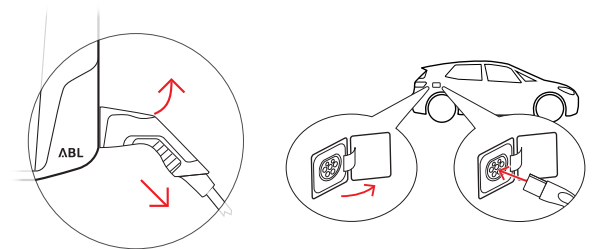

• **Wallbox with charging socket**

Open the charging inlet at the vehicle and plug in the charging connector. Then open the charging socket lid on the wallbox and plug in the charging connector.

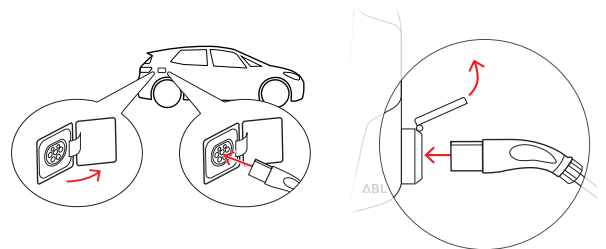

4 Check the LEDs on the wallbox:

- If the wallbox is waiting for authorisation of the charging procedure by the electric vehicle, the green LED is ON while the blue LED is OFF.

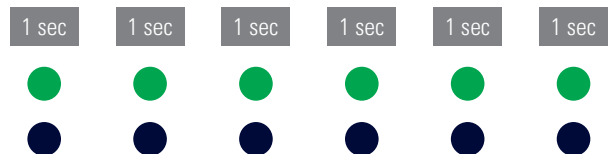

NOTE

Initiation of charging procedure

The vehicle determines when the charging procedure begins:

- The vehicle must request the initiation of the charging procedure.

5 Check the LEDs on the wallbox:

- While the charging procedure is active, the blue LED will be continuously ON and the green LED will be OFF.

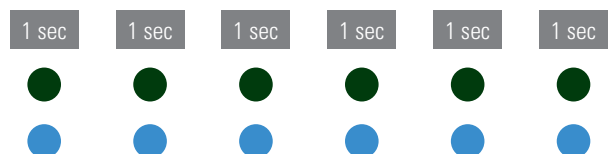

- When the charging procedure has been completed or interrupted, the blue LED will flash every 2 seconds while the green LED will be OFF.

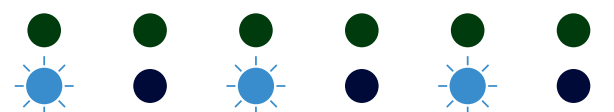

NOTE

Completion of charging procedure

The vehicle determines when the charging procedure ends.

- The charging procedure may be paused by the vehicle.
- The charging procedure is automatically terminated by the vehicle upon completion.

- 6 Unplug the charging connector from the electric vehicle's charging inlet and close it.

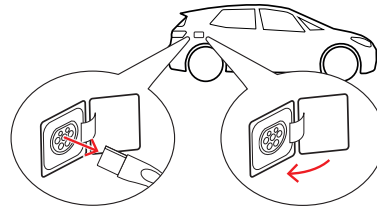

- 7 Store the charging cable ready for the next charging procedure.

- **Wallbox with charging cable**
Replace the charging connector in its storage compartment.
- **Wallbox with charging socket**
Unplug the charging connector from the charging socket and store the charging cable: the charging socket flap closes automatically.

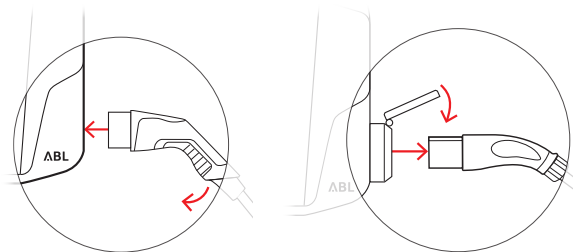

This completes the charging procedure.

NOTE

Storing the charging cable

- **Wallbox eMH1 with charging socket**

If the wallbox has a charging socket, the charging cable should be unplugged from the charging socket after every charging procedure: Otherwise, communication between the wallbox and the vehicle may be disrupted during subsequent charging procedures. roll the charging cable up tightly and store it in the vehicle or near the wallbox.

- **Wallbox eMH1 with charging cable**

You can wind the charging cable closely around the wallbox to reduce trip hazards.

Error resolution and maintenance

Under certain circumstances, malfunctions may occur during operation that prevent or restrict charging operations. The Wallbox eMH1 independently detects errors and indicates them in the form of cyclically repeating LED flash patterns.

Identifying errors

The following errors may occur:

Error F1

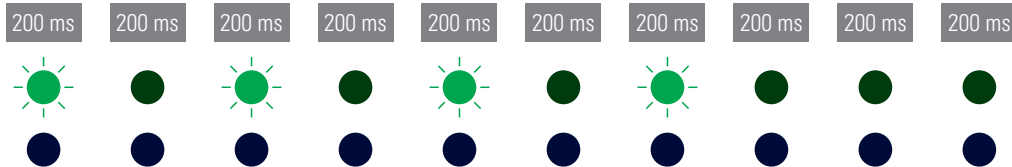

Description

The green LED flashes four times per cycle while the blue LED is OFF.

Cause

The main contactor of the wallbox does not open.

Suggested solution

- Switch the electricity supply for the wallbox off and then back on again. This should automatically reset the error.
- Should the error persist, please contact a qualified specialist electrical contractor to resolve the error.

Error F2

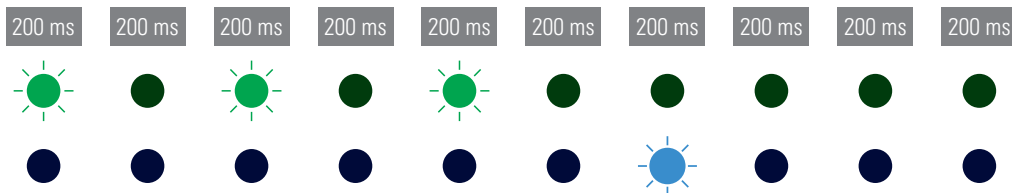

Description

Per cycle, the green LED flashes three times, followed by the blue LED flashing once.

Cause

The firmware has detected a disallowed operating state during the initial or a periodic self-test.

Suggested solution

- Switch the electricity supply for the wallbox off and then back on again. This should automatically reset the error.
- Should the error persist, please contact a qualified specialist electrical contractor to resolve the error.

Error F3

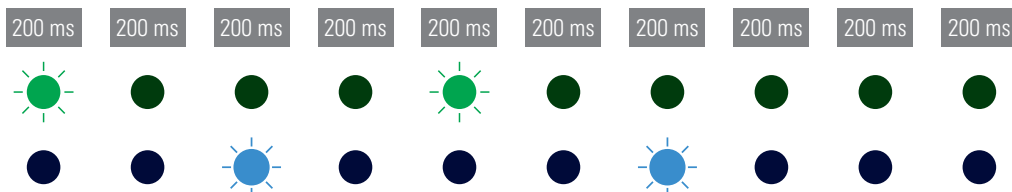

Description

Per cycle, the green and blue LEDs alternately flash twice each.

Cause

The internal DC fault current module has detected a DC fault current.

Suggested solution

- If the error occurs for the first time, the charging procedure is interrupted for 30 seconds and then restarted automatically. If the error occurs again immediately, the charging procedure is terminated permanently: A new charging procedure is only possible after disconnecting the vehicle from the wallbox.
- There is possibly an electrical fault in the charging system of the vehicle. Do not charge the vehicle, and immediately contact a qualified specialist repairer. In addition, consider the notices provided in the operating manual for the vehicle.

Error F5 (variants with charging socket only)

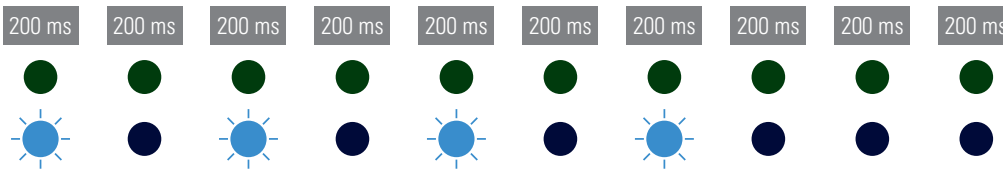

Description

Per cycle, the green LED flashes four times while the blue LED is OFF.

Cause

The charging cable plug could not be locked inside the charging socket of the wallbox.

Suggested solution

- The wallbox automatically reinitiates the charging procedure every 60 seconds. Should the error occur again, check the position of the plug in the charging socket, or unplug it and plug it back in.
- Should the error persist, please contact a qualified specialist electrical contractor to resolve the error.

Error F6 (variants with charging socket only)

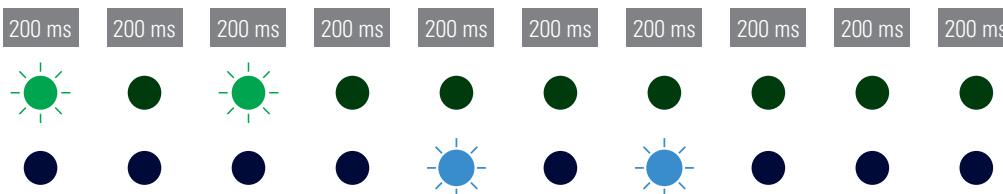

Description

Per cycle, the green LED flashes twice, followed by the blue LED flashing twice.

Cause

The charging cable's current rating is incorrect.

Suggested solution

- The wallbox automatically reinitiates the charging procedure every 60 seconds. Should the error occur again, check the position of the plug in the charging socket, or unplug it and plug it back in.
- Should the error persist, please contact a qualified specialist electrical contractor to resolve the error.

Error F7

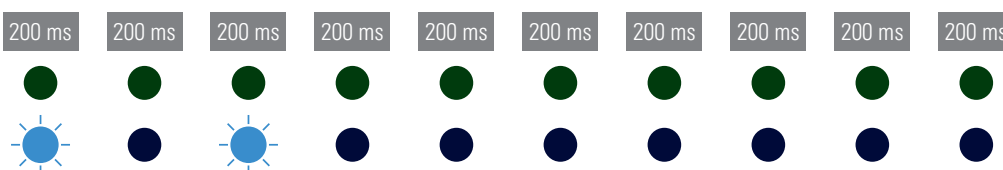

Description

Per cycle, the blue LED flashes twice, while the green LED is OFF.

Cause

The vehicle demands a charging procedure with ventilation: charging vehicles that require ventilation during the charging procedure is not possible with the Wallbox eMH1.

Suggested solution

- The wallbox automatically reinitiates the charging procedure every 60 seconds. Should the error persist, please contact a specialist electrical contractor to have the error resolved.

Error F8

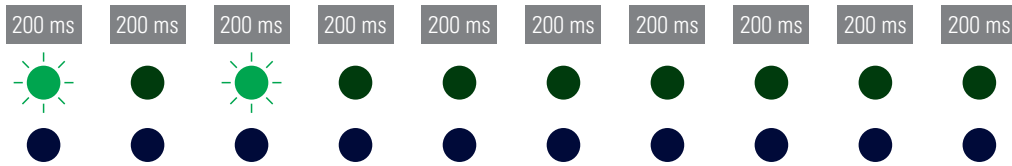

Description

The green LED flashes twice per cycle while the blue LED is OFF.

Cause

A short circuit has been detected between the pilot contact CP and the protective earth PE, or the communication interface of the vehicle is faulty.

Suggested solution

- The wallbox automatically reinitiates the charging procedure every 60 seconds. Should the error persist, please contact a specialist electrical contractor to have the proper functioning of the charging cable and the wallbox checked.
- If no fault was found when checking the charging cable, the vehicle must be checked: please contact a qualified specialist repairer.

Error F9

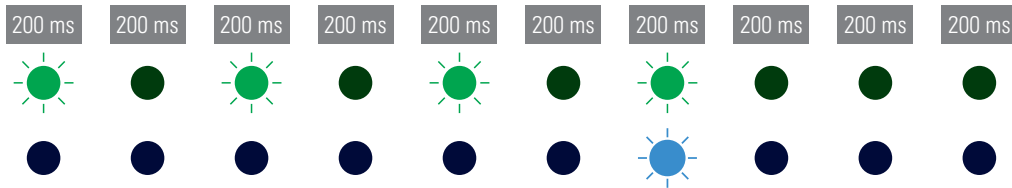

Description

Per cycle, the green LED flashes four times, the blue LED also flashes every fourth time.

Cause

The electrical current monitoring module has detected that the charging current is exceeding the preset maximum current.

Suggested solution

- The wallbox automatically reinitiates the charging procedure every 60 seconds. If the error continues to occur, the vehicle must be checked: please contact a qualified specialist repairer.

Error F10

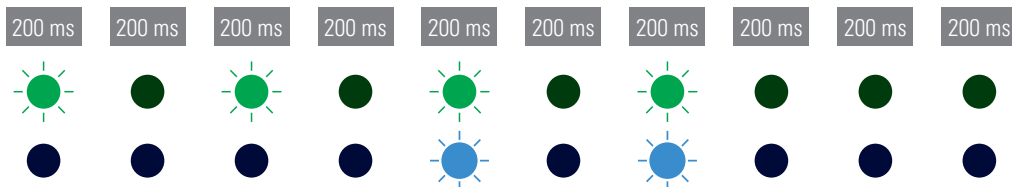

Description

Per cycle, the green LED flashes four times, the blue LED also flashes every third and fourth time.

Cause

The temperature monitoring device has detected a temperature above 80° Celsius inside the housing.

Suggested solution

- The temperature monitoring device interrupts the charging procedure. After 10 minutes, the charging procedure is reinitiated automatically. If the temperature inside the housing remains at between 60° and 80° Celsius at this time, error code **F17** (see below) is shown and the charging current is limited to 6 A.
- The charging procedure is re-initiated as soon as the temperature inside the housing falls to below 60° Celsius.
- If the error repeats or persists, the wallbox must be cooled and/or shaded more effectively at the installation site.
- Should the error persist, please contact a qualified specialist electrical contractor to resolve the error.

Error F11

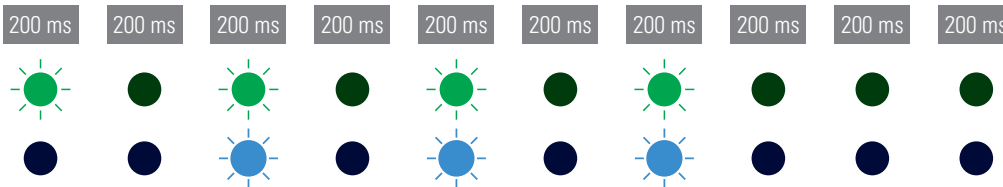

Description

Per cycle, the green LED flashes four times, the blue LED also flashes every second, third and fourth time.

Cause

The main contactor of the wallbox does not close.

Suggested solution

- The wallbox automatically re-initiates the charging procedure every 60 seconds and repeats this process for 10 minutes. If this error persists and the charging procedure is not initiated automatically, the wallbox must be taken out of operation and checked: For this purpose, please contact ABL technical support (see "Contact" on page II).

Errors F16 and F17

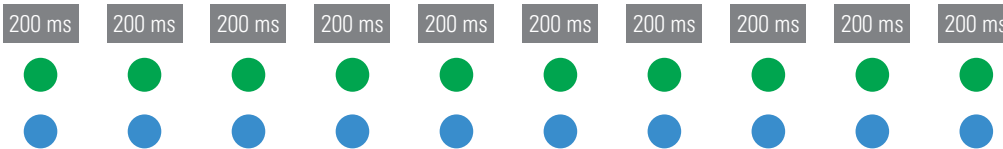

Description

Both the green and blue LEDs are continuously ON during the cycle.

Cause

- Data transfer to the integrated current monitoring device is disrupted: The maximum charging current is limited to 10 A while this error persists.
- The temperature monitoring device has detected a temperature between 60° and 80° Celsius inside the housing: The maximum charging current is limited to 6 A.

Suggested solution

- Charging operations may continue, but the charging output will be reduced. If the error repeats or persists, the wallbox must be cooled and/or shaded more effectively at the installation site. Please contact a qualified specialist electrical contractor to check and resolve the error, or to move the installation site of the wallbox.

NOTE

Operating the wallbox on the mounting plate with key switch (1W0001)

If the Wallbox eMH1 is operated on the separately available Mounting Plate 1W0001, both LEDs being continuously ON indicates that the charging procedure has not yet been authorised using the key switch (switch position **0**).

- Turn the key switch to the **1** position in order to authorise the charging procedure.
- Only return the key switch to the **0** position after the charging procedure has been completed. Otherwise the charging procedure will be interrupted immediately.

**WARNING!****Troubleshooting is not possible**

- Should the wallbox keep displaying error messages, please take it out of operation (see “Taking the Wallbox eMH1 out of operation” on page 30) and contact a qualified specialist electrical contractor to resolve the error.
- Should one of the following malfunctions occur, please contact ABL technical support (see “Contact” on page II).

General operational malfunctions

Under certain circumstances, other malfunctions may occur.

Description

The electric vehicle is not recognised.

Cause and suggested solution

- The charging cable is not properly plugged in.
 - Remove the charging connector from the vehicle's charging inlet and plug it back in.
 - **For wallboxes with charging socket:** also remove the charging connector from the charging socket of the wallbox and plug it back in.
 - Check the charging cable for damage and replace it if required.

Description

The LEDs of the wallbox are not functioning.

Cause and suggested solution

- The wallbox is not connected to the electricity grid.
 - Check the RCCB (internal or upstream in your domestic power distribution) and switch it back on if required.
 - Check the upstream circuit breaker in your domestic power distribution and switch it back on if required.
 - Have a qualified specialist electrical contractor check the power supply cable and restore it if required.
- The wallbox is defective.
 - Please contact a qualified specialist electrical contractor to have the error resolved.
 - Should the wallbox have to be replaced, please contact the dealer from whom you have purchased your wallbox.

**WARNING!****Taking the wallbox out of operation in the event of visible damage**

Should the charging cable, the charging plug or connector show visible damage, you must under no circumstances perform another charging procedure. Take the wallbox out of operation (see further below) and contact a qualified specialist electrical contractor.

Checking the internal RCCB

To ensure the continuing safe operation of the wallbox, the function of the RCCB must be tested regularly according to locally applicable regulations (e.g. every 6 months in Germany): For this purpose, the RCCB has a push button with which to initiate the test function.

NOTE

- The Wallbox eMH1 is available with or without integrated RCCB.
- Should your Wallbox eMH1 not have an integrated RCCB, one must be present upstream in the domestic power supply.

Proceed as follows to test the RCCB:

- 1 Open the housing cover of the wallbox using the key supplied and flip it up.
 - **Wallboxes without integrated RCCB:** The RCCB must be installed upstream in the domestic power distribution: open the domestic power distribution box.
- 2 Locate and press the push button engraved **T** or marked **Test**.
 - The RCCB should now trip and flick its pivot lever into the centre position (connection to the electricity grid is interrupted).
- 3 Now flip the pivot lever first to the **0** position and then back to the **I** position.
- 4 Close the housing cover of the wallbox and/or the domestic power distribution box.

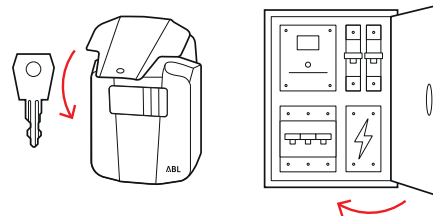
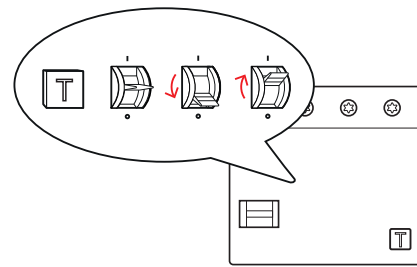
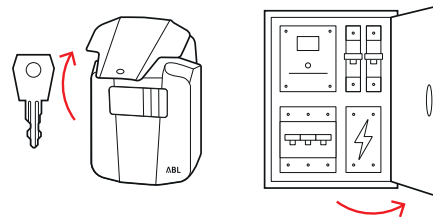

WARNING!

Dangerous electrical currents

Should the RCCB malfunction during testing, you must not continue to operate the wallbox under any circumstances!

- Contact a qualified specialist electrical contractor to have the error resolved.

Taking the Wallbox eMH1 out of operation

In case of severe malfunctions or damage to the device, you must take the Wallbox eMH1 out of operation.

To do so, proceed as follows:

Wallboxes eMH1 with integrated RCCB only:

- 1 Open the housing cover of the wallbox using the key supplied and flip it up.

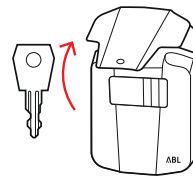

- 2 Flip the pivot lever of the internal RCCB to the 0 position.

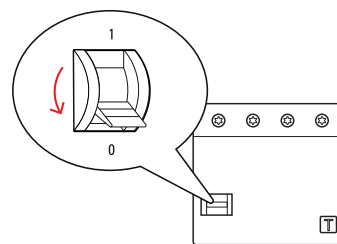

- 3 Close and lock the housing cover of the wallbox.

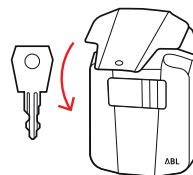

All Wallboxes eMH1:

- 4 Open your domestic power distribution box and disconnect the power supply cable from the electricity grid.
 - **Wallboxes without integrated RCCB:** In addition, flip the pivot lever of the RCCB to the 0 position.
 - Close the domestic power distribution box.

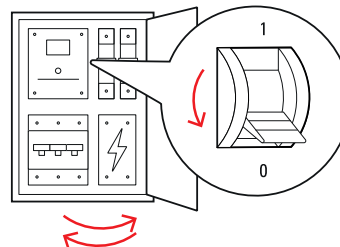

The Wallbox eMH1 is no longer connected to the electricity grid and can be removed by a qualified specialist electrical contractor if required.



WARNING!

Dangerous electrical currents

Always measure the voltage between the phases and the neutral conductor of the power supply cable before you start dismantling the wallbox.

Maintenance

Except for testing the integrated or upstream RCCB, your wallbox is basically maintenance-free. However, we still recommend the wallbox is regularly cleaned and the function of its charging interfaces checked:

- Use only a dry cloth for cleaning the wallbox. Do not use aggressive cleaning agents, waxes or solvents (such as cleaning fluid or paint thinner) as they may dull the wallbox displays.
- The wallbox must under no circumstances be cleaned with a pressure cleaner or similar device.
- Check the fixed charging cable or the charging socket of the wallbox regularly for signs of damage.

Appendix

Technical specifications

7.2 kW series

Model code	1W7201	1W7208	1W7221
Rated voltage	230 V		
Grid frequency	50 Hz		
Current	32 A		
Maximum output	7.2 kW		
Charging connection	Type 2 charging cable (ca. 6 m)		Type 2 charging socket
Phase system	1-phase		
Residual Current Devices	RCCB, Type A, 30 mA	Type A RCCB required onsite	RCCB, Type A, 30 mA
DC fault current detection	DC-RCM, $I_{\Delta n.d.c.} \geq 6$ mA		
Overcurrent protection	–	–	Integrated into firmware, disconnection at 105% after 1,000 seconds, at 110% after 100 seconds, at 120% after 10 seconds
Compliance standards	IEC 61851-1		
Control / customisation	Internal RS485 interface		
Terminal blocks	up to 50 mm ²		
Ambient temperature	-25°C to 40°C		
Storage temperature	-30°C to 85°C		
Relative humidity	5 to 95%, no condensation		
Class of protection	I		
Degree of protection (housing)	IP54		
Overtoltage category	III		
Dimensions (H × W × D)	273 × 222 × 116 mm (housing without overhangs)		
Weight per unit	approx. 4.5 kg		approx. 3 kg

11 kW series

Model code	1W1121	1W1101	1W1108
Rated voltage	230 / 400 V		
Grid frequency	50 Hz		
Current	16 A		
Maximum output	11 kW		
Charging connection	Type 2 charging socket	Type 2 charging cable (ca. 6 m)	
Phase system	3-phase		
Residual Current Devices	RCCB, Type A, 30 mA		Type A RCCB required onsite
DC fault current detection	DC-RCM, $I_{\Delta n.d.c.} \geq 6$ mA		
Overcurrent protection	Integrated into firmware, disconnection at 105% after 1,000 seconds, at 110% after 100 seconds, at 120% after 10 seconds	–	–
Compliance standards	IEC 61851-1		

Model code	1W1121	1W1101	1W1108
Control / customisation	Internal RS485 interface		
Terminal blocks	up to 50 mm ²		
Ambient temperature	-25°C to 40°C		
Storage temperature	-30°C to 85°C		
Relative humidity	5 to 95%, no condensation		
Class of protection	I		
Degree of protection (housing)	IP54		
Overvoltage category	III		
Dimensions (H × W × D)	273 × 222 × 116 mm (housing without overhangs)		
Weight per unit	approx. 3 kg	approx. 4.5 kg	

22 kW series

Model code	1W2221	1W2201	1W2208
Rated voltage	230 / 400 V		
Grid frequency	50 Hz		
Current	32 A		
Maximum output	22 kW		
Charging connection	Type 2 charging socket	Type 2 charging cable (ca. 6 m)	
Phase system	3-phase		
Residual Current Devices	RCCB, Type A, 30 mA		Type A RCCB required onsite
DC fault current detection	DC-RCM, $I_{\Delta n \text{ d.c.}} \geq 6 \text{ mA}$		
Overcurrent protection	Integrated into firmware, disconnection at 105% after 1,000 seconds, at 110% after 100 seconds, at 120% after 10 seconds		
Compliance standards	IEC 61851-1		
Control / customisation	Internal RS485 interface		
Terminal blocks	up to 50 mm ²		
Ambient temperature	-25°C to 40°C		
Storage temperature	-30°C to 85°C		
Relative humidity	5 to 95%, no condensation		
Class of protection	I		
Degree of protection (housing)	IP54		
Overvoltage category	III		
Dimensions (H × W × D)	273 × 222 × 116 mm (housing without overhangs)		
Weight per unit	approx. 3 kg	approx. 4.5 kg	

Standards and guidelines

General standards

2014/30/EU	EMC Guideline
2011/65/EU	RoHS Guideline
2012/19/EU	WEEE Directive
2014/35/EU	Low voltage directive

Standards governing electromagnetic interference (EMV)

IEC 61851-21-2	Conductive charging systems for electric vehicles – Part 21-2: EMC requirements for off board electric vehicle charging systems
----------------	---

Device safety standards

IEC 61851-1 Ed. 3	Electrical equipment for electric road vehicles - conductive charging systems for electric vehicles – Part 1: General requirements
IEC 60364-7-722 Ed. 1	Low voltage installations - Part 7-722: Requirements for special installations or locations - Supply of electric vehicles

Trademarks

All trademarks mentioned in this manual, including those that may be protected by third parties are, without restriction, subject to the regulations of the respectively applicable trademark law and the property rights of the respective registered owners. All trademarks, trading names or company names marked here as such are, or may be, trademarks or registered trademarks of their respective owners. All rights not explicitly granted here are reserved.

The absence of explicit identification of trademarks used in this manual must not lead to the conclusion that a name is free from the rights of third parties.

Dimensions

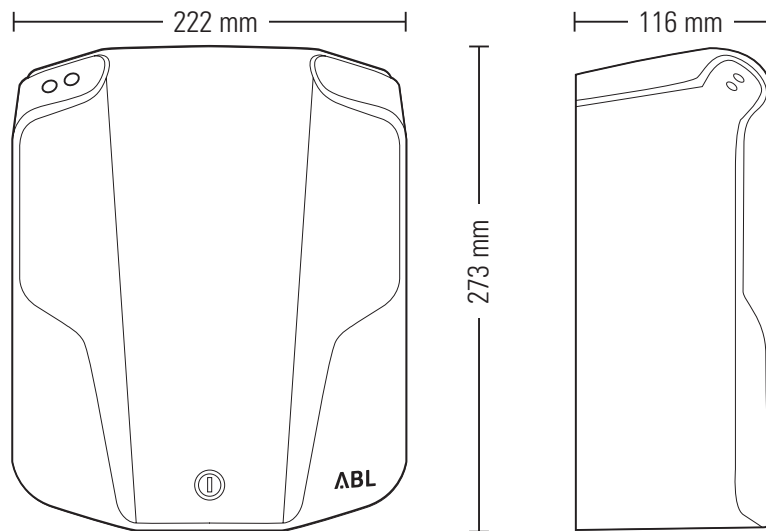

NOTE

Housing dimensions without overhangs

The dimensions quoted above relate to the housing base of the Wallbox eMH1: Charging connections (charging socket or the charging connector stored in the receptacle on the side of the wallbox) are not included in these dimensions.

Definitions

Abbreviation	Explanation
DC	Direct Current
eMH	Electric Mobility Home
EVCC	Electric Vehicle Charge Controller
LED	Light Emitting Diode
RCCB	Residual Current operated Circuit Breaker
RCM	Residual Current Monitor
RFID	Radio Frequency Identification
'T' button	Testing button

Copyright and disclaimer

Copyright © 2021

Version 0301803_EN_e, date: 17/07/2021

All rights reserved.

- Any information contained in this manual may be changed without prior notice and does not represent any obligation on the part of the manufacturer.
- Illustrations in this manual may show designs different from the delivered product and do not represent any obligation on the part of the manufacturer.
- The manufacturer does not take responsibility for any loss and/or damage that occurs because of the data or possible misinformation contained in this manual.

CE certification and declaration of compliance



The Wallbox eMH1 carries the CE mark.

The associated compliance declaration is available on request from ABL SURSUM Bayerische Elektrozubehör GmbH & Co. KG as a download at www.ablmobility.de in the Service > All downloads > Compliance declarations section, and a copy is shown here.

ZERTIFIKAT / CERTIFICATE		ABL
EU - KONFORMITÄTSERKLÄRUNG EC - DECLARATION OF CONFORMITY		
Name des Herstellers Name of manufacturer	ABL SURSUM Bayerische Elektrozubehör GmbH & Co. KG Albert-Büttner-Straße 11 91207 Lauf an der Pegnitz, Germany	
erklärt, dass das Produkt declares that the product	Ladestationen für Elektrofahrzeuge. Charging station for electric vehicles	
Type-Nr. Ref. No.	Wallbox eMH1	
die Forderungen folgender europäischer Richtlinien erfüllt: is in conformity with the following European Directives:	<input checked="" type="checkbox"/> Niederspannungsrichtlinie/Low Voltage Directive 2014/35/EU <input checked="" type="checkbox"/> EMV Richtlinie / EMC Directive 2014/30/EU <input checked="" type="checkbox"/> RoHS Richtlinie 2011/65/EU <input type="checkbox"/>	
Angewendete (harmonisierte) Normen: Applied (harmonized) standards:	IEC 61851-1:2010-11 Ed. 2.0 IEC 61851-22:2001-05 EN 61000-6-2:2006-03 EN 61000-6-3:2011-09 VDE-AR-N 4100:2019-04	
Diese CE-KONFORMITÄTSERKLÄRUNG gilt für alle im Anhang gelisteten Produkte. This CE-DECLARATION OF CONFORMITY is valid for all products in the annex.		
Jahr der Anbringung der CE-Kennzeichnung: Year of declaration:	2016	

ABL SURSUM GmbH & Co.KG Lauf / Pegnitz Lauf / Pegnitz		
6.04.2020		
Datum / Date Date	Unterschrift Signature	i.A. Helmut Mann Abteilungsleiter Entwicklungslabor und Zertifizierung
Diese Erklärung bescheinigt die Übereinstimmung mit den genannten Richtlinien und beinhaltet jedoch keine Zusicherung von Eigenschaften. This declaration certifies the conformity to the specified directives but contains no assurance of properties.		
<small> ABL SURSUM Bayerische Elektrozubehör GmbH & Co. KG Geschäftsführer: Dr. Stefan Schlötus, Sabine Spiller-Schlötus Registergericht Nürnberg HRA 6778 </small>		
<small> Komplementär: ABL SURSUM Bayerische Elektrozubehör Verwaltungs-GmbH Registergericht Nürnberg HRB 4335 </small>		
<small> Albert-Büttner-Str. 11 91207 Lauf/Pegnitz info@abl.de </small>		
<small> T +49 9123 188 0 F +49 9123 188 188 www.abl.de </small>		
<small> USt-IdNr. DE 152 809 180 ILN 40 11721 00000 9 WEEE-Reg Nr. DE54480074 </small>		

Drilling template

The Wallbox eMH1 comes with a drilling template (see illustration below) for marking the fixing points. Should the drilling template have been lost, you can obtain the drilling dimensions from the illustration below.

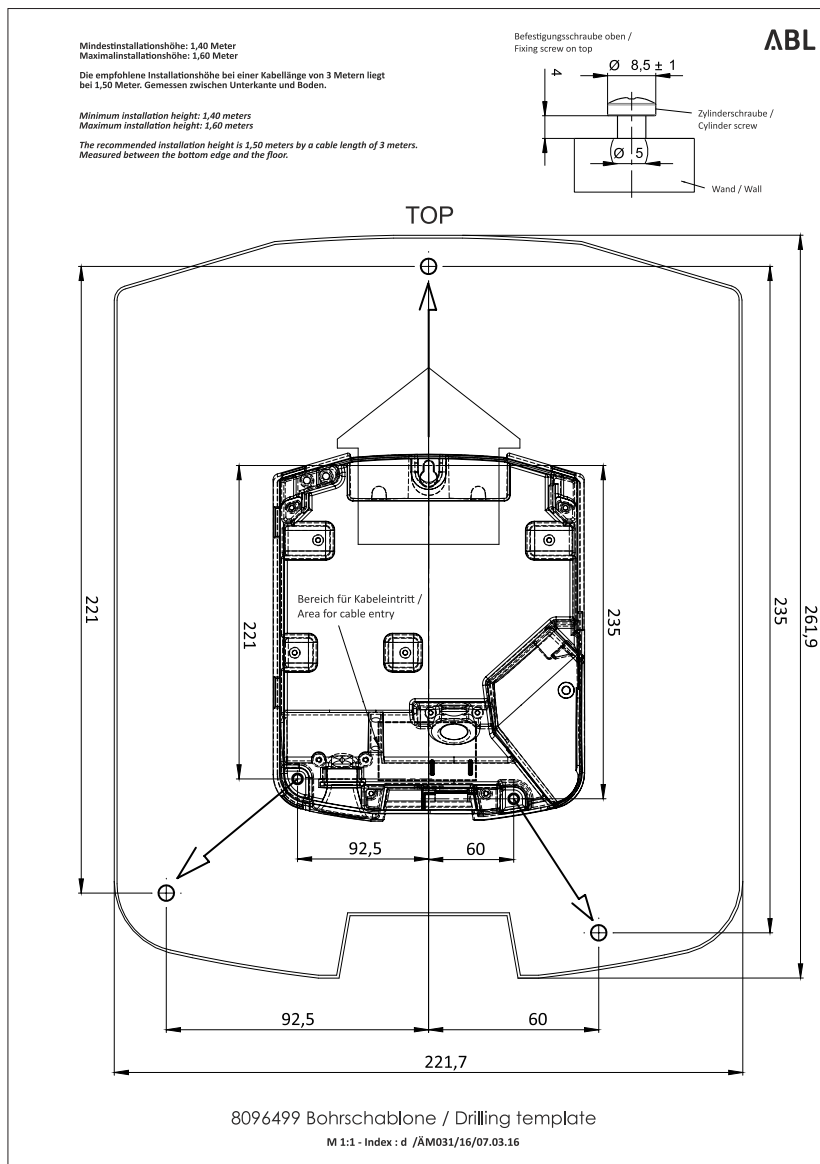

Disposal advice



The crossed out rubbish bin symbol indicates that electrical and electronic devices including accessories must be disposed of separate from household refuse.

The materials are recyclable as marked. The reuse or recycling of materials, or other forms of repurposing of old devices make an important contribution towards protecting the environment.



ABL SURSUM

Bayerische Elektrozubehör GmbH & Co. KG

Albert-Büttner-Straße 11
91207 Lauf an der Pegnitz
Germany



+49 (0) 9123 188-0



+49 (0) 9123 188-188



info@abl.de



www.ablmobility.de