

Energy Management System eMS home



EN

Contact

ABL



ABL GmbH

Albert-Büttner-Straße 11
91207 Lauf an der Pegnitz
Germany

 +49 (0) 9123 188-0
 +49 (0) 9123 188-188

 info@abl.de
 www.ablmobility.de

Customer Service

 +49 (0) 9123 188-0
 service@abl.de
 www.ablmobility.de/de/service/support/



Contents

Contact	2
Additional technical information	5
Information in this document	5
Introduction	6
General	6
Introduction to the Energy Management	
System home	6
Identification of the eMS home	7
Connections and controls	8
RS485 interfaces	9
System installation	10
Phase rotation	10
Electrical connection of the eMS home for direct	
measurement without current transformer	11
Electrical connection of the eMS home for indirect	
measurement with current transformers	12
Bus wiring of the wallboxes and the eMS home	13
Termination of the data lines	15
Setting up the wallboxes	16
Cable connection with the computer	16
Configuration via the ABL Configuration Software	18
Starting up the eMS home	19
Starting the eMS home web interface	20
Structure of the web interface	22
Checking and updating the device firmware	22
Setup via the eMS home web interface	24
Description of the individual apps of the eMS home	27
Dashboard	27
Messages – App Health Check	28
Smart Meter app	30
Wallbox app	31
Data store app	39
Device settings app	43
Appendix	52
Technical specifications	52
Operation of the eMS home at an ambient	
temperature of 55 °C	52
Data cable recommendations	53
PIN allocation within the system	53
LED statuses	53
Functions of the reset button	54
Licences	55
Abbreviations	55
Error codes	55
OBIS system of indicators	57
Data Storage app – CSV export format	58
FAQs – Frequently Asked Questions	62
Disposal notice	63
Intellectual property & copyright	63

Additional technical information

Additional technical information is required for individual or group installation of all eMH1 Wallboxes in connection with the Energy Management System home. This is available in separate documents.

The technical data for the Energy Management System home and the eMH1 Wallboxes are also summarised concisely in product-specific data sheets. You can download these documents from the ABL website using the following link:



<https://www.ablmobility.de/en/service/downloads.php>

! NOTE

Displaying the additional information on a computer, tablet or smartphone

Additional technical information is made available in the Portable Document Format (PDF).

- To display PDF files, you need the free Adobe Acrobat Reader or comparable software.

You can find further information about our product range, as well as about separately available accessory components on our website at www.ablmobility.de. Please visit:



<https://www.ablmobility.de/en>

Information in this document

This document explains how to install and configure the Energy Management System home. It is recommended that all working steps described in this document are carried out by qualified specialist electrical contractors only.

	User	Specialist electrical contractor
User manual (this document)	✗	✓
Additional technical information		
▪ Data sheets	✓	✓
▪ eMH1 installation instructions	✗	✓

Introduction

General

This manual describes all working steps required to install and/or operate the product it concerns. Certain sections of this manual are specially formatted for quick and easy reference.

- ▶ Descriptions of completed actions are marked with a triangle.
- Descriptions listing equally valid options are indicated by bullet points.
- 1 Descriptions listing operating steps are numbered in chronological order.



DANGER!

Indicates life-threatening electrical voltages

Sections marked with this symbol indicate electrical voltages that present a danger of loss of life or grievous bodily injury.

- Actions marked with this symbol must not be carried out under any circumstances.



WARNING!

Indicates important actions and further hazards

Sections marked with this symbol indicate further hazards that may result in damage to the product or to other connected components.

- Actions marked with this symbol must be carried out with special care.



NOTE

Indicates important information for operation or installation

Sections marked with this symbol indicate further important information and features necessary for successful operation.

- Actions marked with this symbol should be carried out as required.
- Passages marked with this symbol contain valuable additional information.

Introduction to the Energy Management System home

The eMS home is recommended as a dynamic energy and load management system for use in private households. The fully integrated three-phase smart meter measures the current energy consumption at the grid connection point and allows the charging current to be dynamically adjusted and distributed in individual and group installations with up to six eMH1 wallboxes. This helps to avoid overloading the house connection. PV surplus charging is possible thanks to surplus metering. The eMS home web interface can be accessed via LAN for configuration and monitoring purposes. This can display the charging status and the current load on the individual phases in a conventional browser.

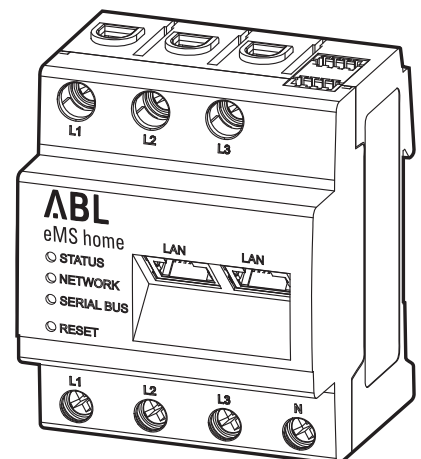

The following measured values are recorded and stored by the eMS home:

- Active power
- Reactive power
- Apparent power
- Active energy (electrical work)
- Reactive energy
- Apparent energy
- Sum of all phases and single phases
- Phase voltages
- Phase currents
- Power factor

Identification of the eMS home

A rating plate attached to the side of the eMS home and another supplied in the package are used for identification purposes. The rating plate contains the following important information:

- Serial number
- MAC address
- Factory-assigned password for logging in to the user interface of the eMS home

Always check the rating plate before installation.

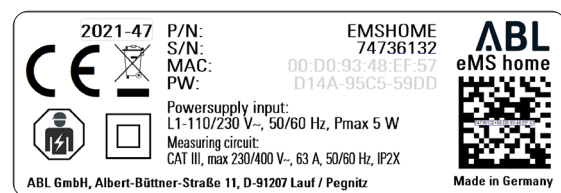

NOTE

Type rating on the packaging

There is another rating plate on the packaging of the eMS home which contains general information such as the product number and serial number. However, it does not show any access data for communication between the integrated web server of the eMS home and a computer.

Connections and controls

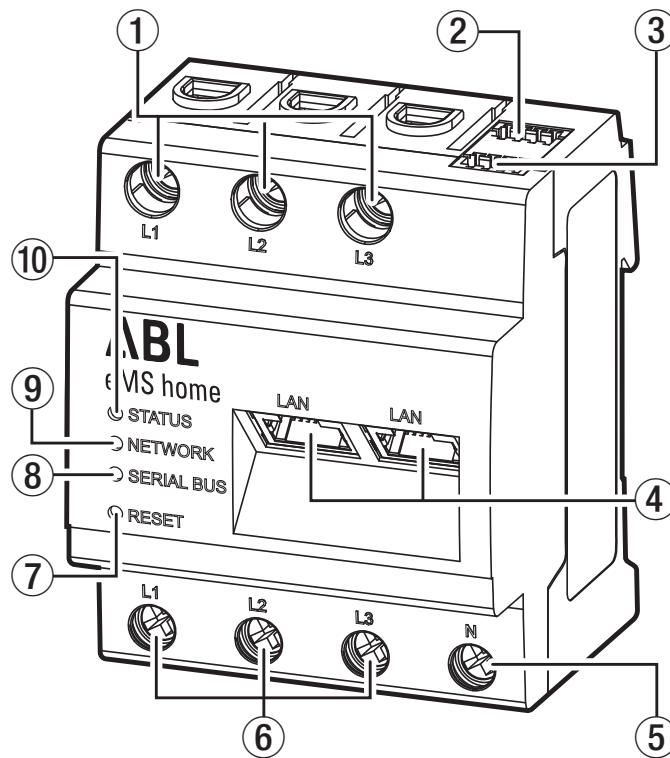

Number	Designation
①	Outer conductor L1, L2, L3 outputs
②	RS485 A connection
③	RS485 B connection
④	2 × LAN connection
⑤	Neutral conductor N
⑥	Outer conductor L1, L2, L3 inputs
⑦	Reset button
⑧	Serial bus LED for RS485 bus
⑨	Network LED
⑩	Status LED

RS485 interfaces

There are two RS485 interfaces on the top of the eMS home (A and B) which are used for communication with the eMH1 Wallboxes. The following specifications apply to the RS485 interfaces:

Requirement for the data cable

- Nominal voltage/wire insulation: 300 V RMS
- Cable cross section: 0.25–1.5 mm²
- Cable type: rigid or flexible
- Recommendation: To do this, please refer to the section on “Data cable recommendations” on page 53.

Requirement for cable installation

- In the area for connecting the RS485 interfaces on the eMS home, mechanical means must be provided to ensure that individual wires of the connecting cable are at least 10 mm away from live parts.
- The connecting cable must be run separately from the mains cables in the distribution board and on the permanent link.

Connection diagram for RS485 connector

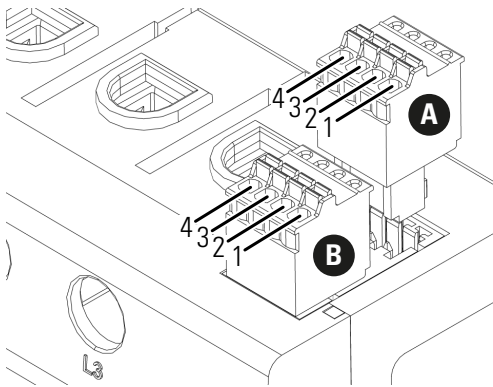

Pin	Labelling	Description
1 A 1 B	VCC	Voltage output for supply of external devices, 5 V ± 10%, max. 280 mA
2 A 2 B	GND	Ground
3 A 3 B	A	RS485 A
4 A 4 B	B	RS485 B

System installation

The Energy Management System eMS home can be used to control up to six eMH1 Wallboxes. Detailed information on how to install the eMH1 Wallbox can be found in the corresponding installation instructions. These are available at:



<https://www.ablmobility.de/en/service/downloads.php>

Phase rotation

For the system to function correctly, the phase rotation must be set up according to the following diagram when installing the wallboxes:

Wallbox	eMH1 – 1				eMH1 – 2				eMH1 – 3				eMH1 – 4				eMH1 – 5				eMH1 – 6							
RCD terminals	L3	L2	L1	N	L3	L2	L1	N	L3	L2	L1	N	L3	L2	L1	N	L3	L2	L1	N	L3	L2	L1	N	L3	L2	L1	N
Supply	L3	L2	L1	N	L1	L3	L2	N	L2	L1	L3	N	L3	L2	L1	N	L1	L3	L2	N	L2	L1	L3	N	L2	L1	L3	N

Wiring diagram
Wallbox 1 and 4

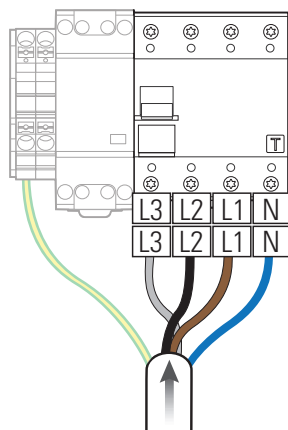

Wiring diagram
Wallbox 2 and 5

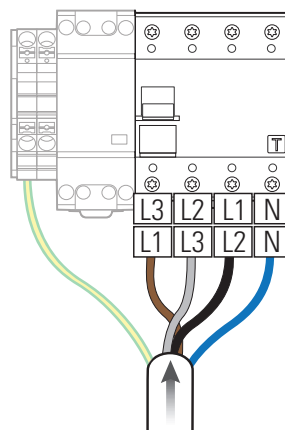

Wiring diagram
Wallbox 3 and 6

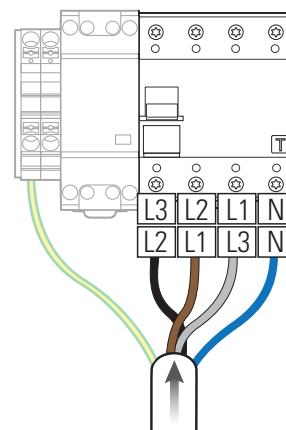

WARNING!

Note on phase rotation and address allocation

- The phase rotation diagram shown above must be followed for the system to work correctly!
- In addition, you must assign the bus addresses of the wallboxes during configuration via the **ABL Configuration Software** (see "Configuration via the ABL Configuration Software" on page 18) according to the above scheme: Wallbox 1 → Bus address 1, Wallbox 2 → Bus address 2 etc.



NOTE

Phase rotation in a single-phase mains system

The connection diagram shown above applies to 3-phase mains systems. If you are using a single-phase mains system, the L1 supply line must always be connected in each wallbox!

Electrical connection of the eMS home for direct measurement without current transformer

When connecting directly to the eMS home, it must be ensured, by fitting a fuse, for example, that the maximum permitted current per phase is not exceeded.

Proceed as follows:

- Mount the eMS home on a top-hat rail.
 - Hook the eMS home onto the top edge of the top-hat rail and press it until it clicks into place.
- Connect the conductors to the eMS home.
 - Pay attention to the permissible connection cross section and the tightening torque for the screw terminal (see "Technical specifications" on page 52).
 - For a three phase power network, connect the outer conductors **L1**, **L2** and **L3** and the neutral conductor **N** to the eMS home as shown in the connection diagram.
 - For a single phase power network, connect the outer conductor **L1** and neutral conductor **N** to the eMS home as shown in the connection diagram.

Designation	Explanation
L1, L2, L3	Outer conductor
N	Neutral
OUT	Meter output, consumer side
IN	Meter input, mains side

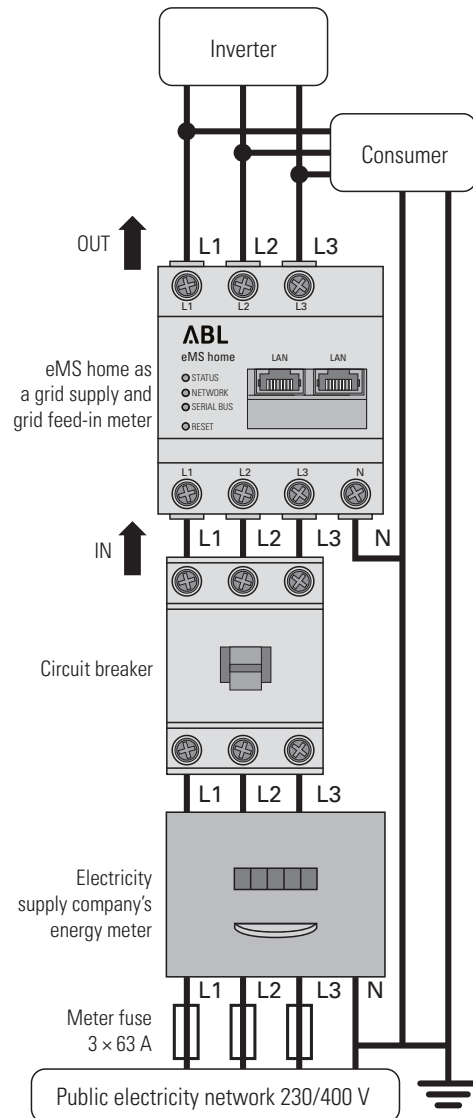

Example for implementation

WARNING!

Use of a meter fuse or circuit breaker

The end user must be able to isolate the eMS home from the power supply by means of a freely accessible meter fuse or an additional circuit-breaker.

WARNING!

Note on the correct assignment of the phases

Make sure that the phases are each assigned correctly. Otherwise, the eMS home will provide incorrect measured values.

Electrical connection of the eMS home for indirect measurement with current transformers

Proceed as follows:

- 1 Mount the eMS home on a top-hat rail.
 - Hook the eMS home onto the top edge of the top-hat rail and press it until it clicks into place.
- 2 Lead the outer conductors L1, L2 and L3 through one current transformer each.
- 3 Connect a cable for the secondary current measurement to each current transformer at terminals k/s1 and I/s2.
 - Pay attention to the permissible connection cross section of the eMS home (see "Technical specifications" on page 52).
- 4 Connect the connecting cables for the current measurement to the eMS home (see also box below).
 - Pay attention to the permissible tightening torque for the screw terminals (see "Technical specifications" on page 52).
- 5 Connect the connecting cables for the voltage measurement to the eMS home (see also box below).
 - Pay attention to the permissible tightening torque for the screw terminals (see "Technical specifications" on page 52).
- 6 Connect the connecting cables for the voltage measurement to the outer conductors L1, L2 and L3.

Designation	Explanation
L1, L2, L3	Outer conductor
N	Neutral
OUT	Meter output, consumer side
IN	Meter input, mains side

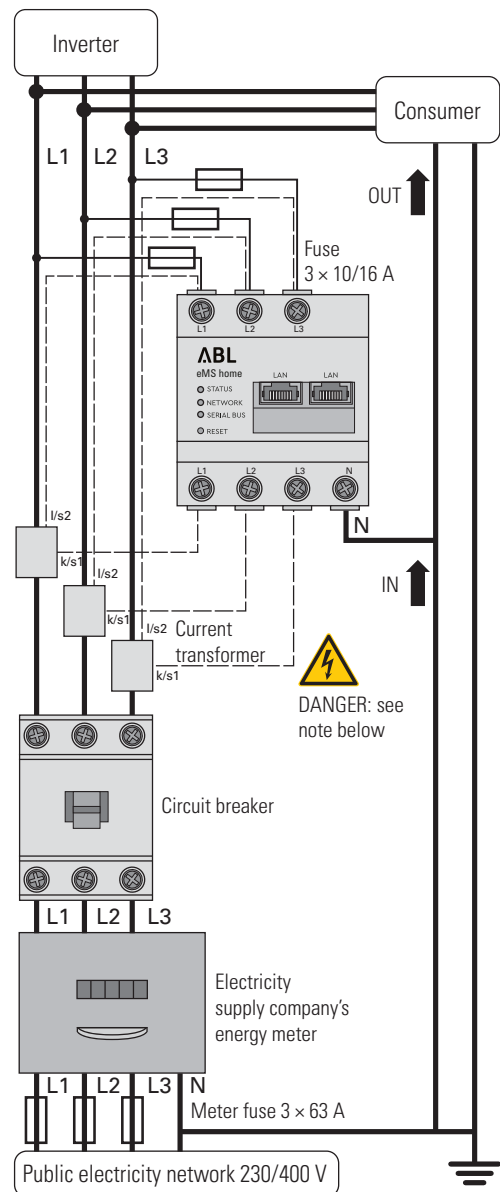

Example for implementation



WARNING!

Specifications for connecting two lines in one terminal

Please observe the following specifications for the connection cables for current and voltage measurement:

- If the cross-sections of the two connection cables for current and voltage measurement differ (greater than $\pm 0.5 \text{ mm}^2$), you should clamp these cables together in a suitable double-wire end sleeve.
- It is not permitted to connect a stranded and a rigid cable together in one terminal.

**DANGER!****Danger of death by electric shock at the current transformer terminals**

The eMS home is supplied with warning stickers which advise the user to read these instructions and which are intended to protect against electric shock and other hazards caused by high currents.

- Due to the type of connection, there is a mains voltage of 230 V present at conductors k/s1 and l/s2.
- To prevent accidents, apply the warning stickers at this location on site.

**WARNING!****Use of a meter fuse or circuit breaker**

The end user must be able to isolate the eMS home from the power supply by means of a freely accessible meter fuse or an additional circuit-breaker.

**WARNING!****Note on the correct assignment of the phases**

Make sure that the phases are each assigned correctly. Otherwise, the eMS home will provide incorrect measured values.

Bus wiring of the wallboxes and the eMS home

To control the charging currents, all wallboxes in the system must be wired via a data cable and each set up via the **ABL Configuration Software** (see "Configuration via the ABL Configuration Software" on page 18 onwards).

- Communication between the eMS home and the eMH1 Wallboxes is via CAT5e or equivalent data lines, which must comply with the specifications in section "Data cable recommendations" on page 53.
- The data lines are connected to the internal spring terminals (for products manufactured before mid-2021) or via the E2I interface (for products manufactured from mid-2021) on the inside left of the eMH1 housing (see next section).
- The data lines are fed in and out via the designated opening ① in the rear shell of the housing (see installation instructions for the eMH1 Wallbox).
- The total length of the data lines within the group installation must not exceed 100 m.

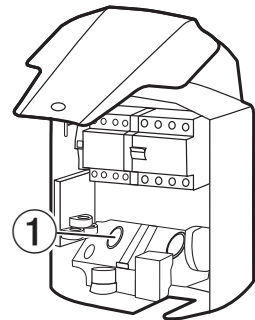
**WARNING!****Important note on plugging in the RS485 connector in the eMS home**

Please note that the RS485 connector may only be plugged into the eMS home after configuration in the **ABL Configuration Software** (see page 18 onwards): Otherwise, there may be problems with communication in the system.

Bus wiring via spring terminals

For bus wiring via spring terminals (for products manufactured before mid-2021), the following generally applies:

- The twisted wires of the data line must be connected to the contacts **evcc/rfid A** and **evcc/rfid B** of the wallboxes' internal spring terminals.

- The colour assignment between the data lines and the contacts **evcc/rfid A**, **evcc/rfid B** and **evcc/rfid M** on the spring terminals must be identical in every wallbox in the system and must not be changed under any circumstances.
- The data line from the previous wallbox is connected to the left spring terminal, and the data line for the following wallbox is connected to the right spring terminal.

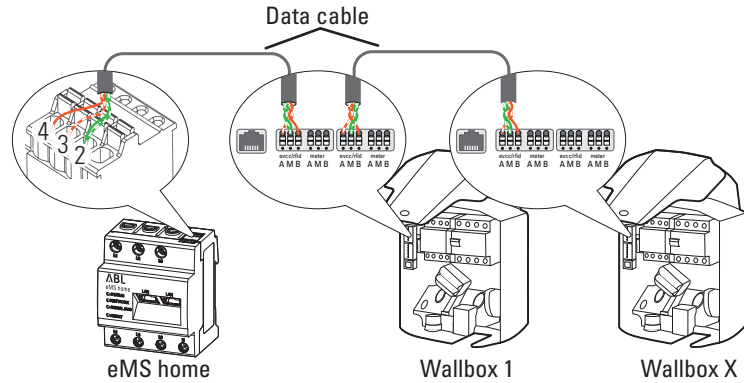

- Connect the data line to the RS485 connector of the eMS home in such a way that it is assigned to the spring terminal in the first wallbox as follows (see also “PIN allocation within the system” on page 53):

RS485 terminal (eMS home)	eMH1 spring terminal
Pin 3	Pin A
Pin 4	Pin B
Pin 2	Pin M

Bus wiring via E2I interface

For bus wiring via the E2I interfaces (for products manufactured from mid-2021), the following generally applies:

- The data line is connected to the internal interfaces in the wallboxes via RJ45 connectors.
- For pre-assembled cables with RJ45 connectors, the colour assignment within the data lines is already predefined. In this case, the assignment to the RS485 terminal of the eMS home must be adapted in accordance with the assignment below.

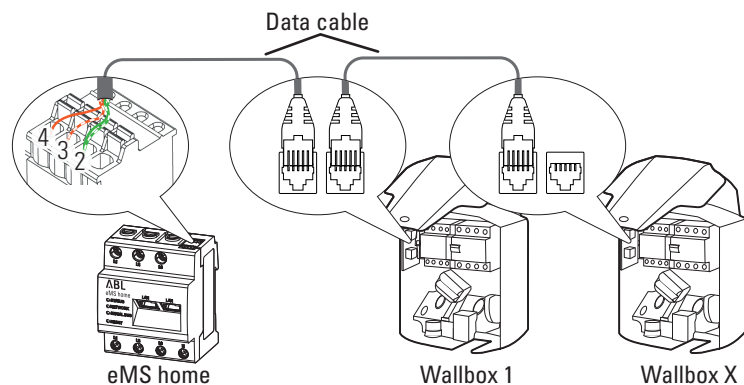

- If you would like to assemble the data cables yourself, you should also use the following assignment as a guide (see also “PIN allocation within the system” on page 53):

RS485 terminal (eMS home)	eMH1 E2I interface pins
Pin 3	1
Pin 4	2
Pin 2	3 & 6

Bus wiring via R12 interface

Some models of the eMH1 Wallbox only have one interface designed as an RJ12 socket, for which the following applies

- The data line is connected to the internal interface in the wallboxes via RJ12 connector.
- For pre-assembled cables with RJ12 connectors, the colour assignment within the data lines is already predefined. In this case (and with self-assembled cables), the assignment to the RS485 terminal of the eMS home must be adapted in accordance with the assignment below.

RS485 terminal (eMS home)	eMH1 Basic RJ12 interface pins
Pin 3	3
Pin 4	4
Pin 2	2 & 5

Termination of the data lines

To ensure correct communication via the bus, the data line must be terminated at the RS485 connector of the eMS home and at the Modbus interface of the last wallbox in the group installation. To this end, the eMS home is supplied ex works with two terminating resistors and two jumpers, which are required for terminating the respective interfaces.

Termination at the eMS home

- ▶ Insert the enclosed terminating resistor between test pins **3** and **4** on the RS485 connector of the eMS home.
- Always keep a minimum distance of 10 mm from live parts.

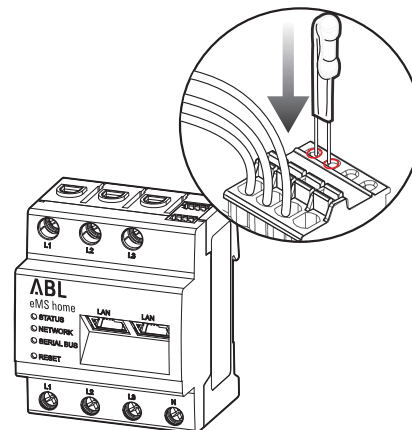

Termination of a wallbox with spring terminals

(eMH1 before mid-2021)

- ▶ Insert the enclosed terminating resistor in the spring terminal which is not connected to the data lines, between terminals **A** and **B** of **evcc/rfid**.

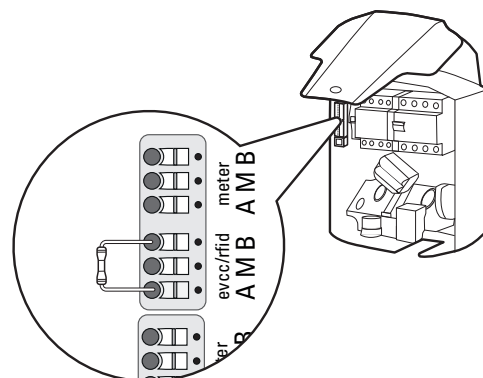

Termination of a wallbox with E2I interface

(eM1 from mid-2021)

- ▶ Connect the pin contacts of the E2I interface marked **CONTROL** and **METER** using a jumper for each.

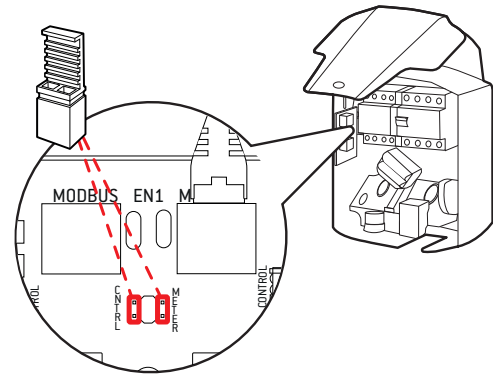

Setting up the wallboxes

To communicate with the eMS home, all wallboxes in the system must be set up individually and given their own address. Setup and address allocation are carried out via the **ABL Configuration Software**, which is available for download at <https://www.ablmobility.de/en> under **Service > All downloads > Software > Configuration Software**. To do this, after completing the mechanical and electrical installation of the wallboxes, establish a data connection between the computer on which the **ABL Configuration Software** is installed and the bus interface of the wallboxes.

Cable connection with the computer

To connect the Wallbox eMH1 to a Windows PC, you will need the configuration kit CONFCAB (separately available accessory), which makes the wallbox's Modbus interfaces compatible with the computer's USB port. Using CONFCAB components, any charging station from the Wallbox eMH1 product series can be connected by cable:

- ① USB extension cable
- ② USB to RJ45 adapter
- ③ RJ45 to individual strands patch cable
- ④ RJ45 to RJ12 patch cable
- ⑤ RJ45 to RJ45 patch cable



WARNING!

Cabling via CONFCAB

Only use the cables and adapters contained in the CONFCAB kit to connect your Wallbox eMH1 to the computer. Otherwise, faultless communication cannot be guaranteed.

Proceed as follows to connect the Wallbox eMH1 with the computer by cable:

Wallbox eMH1 with spring terminals (until mid-2021)

- 1 Remove the upper part of the housing.
 - This procedure is described in the section “Preparing and mounting the wallbox” in the installation instructions for the eMH1 Wallbox.
- 2 Connect the patch cable ③ to the spring terminals located on the left hand side of the interior of the last wallbox.
- 3 Connect the USB extension cable ① to one of the computer's USB ports.
- 4 Use the USB to RJ45 adapter ② to connect the patch cable ③ to the USB extension cable ①.

The wallbox is now connected to the computer by cable.

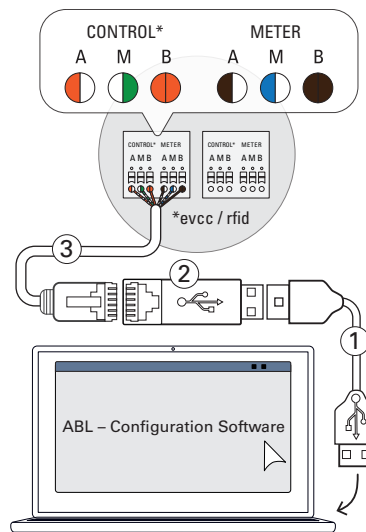

eMH1 Wallbox with RJ12 interface

- 1 Remove the upper part of the housing.
 - This procedure is described in the section “Preparing and mounting the wallbox” in the installation instructions for the eMH1 Wallbox.
- 2 Connect the patch cable ④ to the RJ12 port located on the left hand side of the interior of the last wallbox.
- 3 Connect the USB extension cable ① to one of the computer's USB ports.
- 4 Use the USB to RJ45 adapter ② to connect the patch cable ④ to the USB extension cable ①.

The wallbox is now connected to the computer by cable.

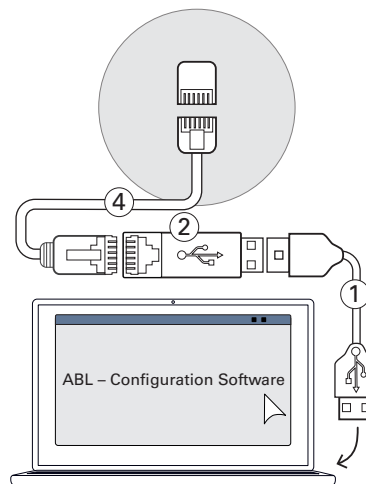

Wallbox eMH1 with E2I interface (from mid-2021)

- 1 Remove the upper part of the housing.
 - This procedure is described in the section “Preparing and mounting the wallbox” in the installation instructions for the eMH1 Wallbox.
- 2 Connect the patch cable ⑤ to one of the RJ45 ports located on the left hand side of the interior of the last wallbox.
- 3 Connect the USB extension cable ① to one of the computer's USB ports.
- 4 Use the USB to RJ45 adapter ② to connect the patch cable ⑤ to the USB extension cable ①.

The wallbox is now connected to the computer by cable.

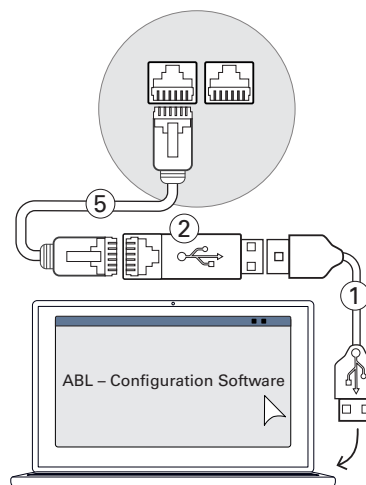

Configuration via the ABL Configuration Software

After you have set up the cabling between the wallbox(es) and the computer, you can start configuring the wallboxes in the **ABL Configuration Software**.

Proceed as follows to set the operating mode of the wallboxes.

- 1 Set the RCD of all charging stations to position 0.
 - This means that all charging stations are disconnected from the power supply.
- 2 Set the RCD of the last charging station to position I.

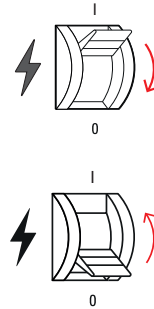

- 3 Start the **ABL Configuration Software** and click on the **Individual configuration** tab on the start page.
- 4 Click the **Scan** button.
 - Basic information about the detected charging station is now displayed below the **Scan** button.

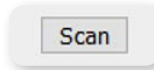
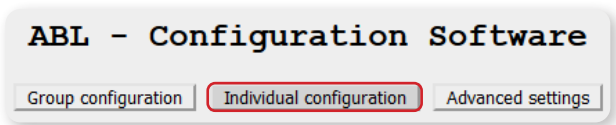

- 5 Click on the **Controller / Extender** radio button to set the operating mode for this charging station.

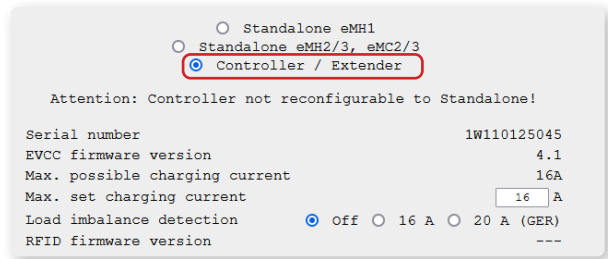

NOTE

Adaptation of further configuration options

If necessary, you can now adjust other parameters for the charging station such as **Max. set charging current**.

- 6 Press the **Group configuration** button to switch to that tab and enter the address of the charging station.

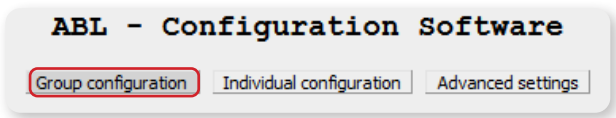

- 7 Click the **Scan** button on the right-hand side.

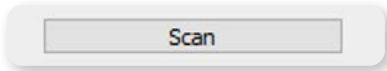

- 8 To change the address of the charging station, enter the current address value in the left-hand field (in this example: 3).

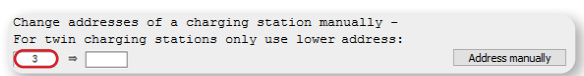

9 Now enter the new destination address for the charging station in the right-hand field (in this example: 6).

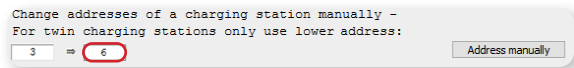

10 Click the **Address manually** button.

- The new address value is now activated.

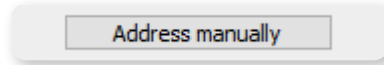

ADDRESS	1	2	3	4	5	6	7	8	9	10	11	12	13	14	15	16
TYPE						single										
EVCC						6										
RFID																
LGM																
METER																
SERIALNUM						S/A										

11 Set the RCD of the addressed charging station to position 0.

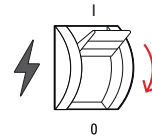

12 Repeat steps 2 to 11 for all other charging stations in the group, leaving all already addressed charging stations switched off.

13 After addressing all charging stations, set the RCDs of all charging stations to position I.

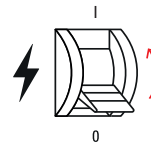

After completing the configuration, you can exit the **ABL Configuration Software** and disconnect the data cabling with the computer via the CONF CAB cable.

Starting up the eMS home

After addressing and setting up the wallboxes, you can complete the wiring of the data cables between the eMS home and the wallboxes by inserting the RS485 connector in the eMS home and then starting up the eMS home via a PC/laptop. To do so, proceed as follows:

1 Close and lock all eMH1 Wallboxes in the system.

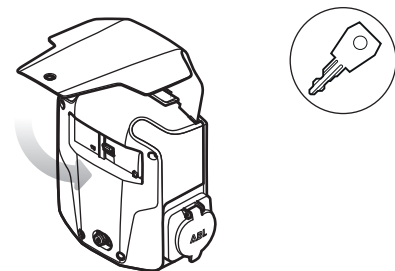

2 Switch off the house connection.

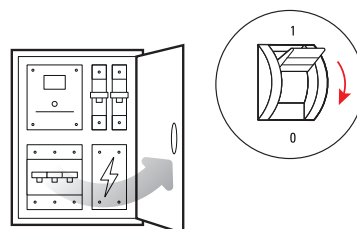

- 3 Insert the RS485 connector into the connector socket **B** on the top of the eMS home.
 - Make sure the data lines are also still firmly connected to the RS485 connector after plugging in.
 - Make sure that the terminating resistor is still firmly seated between test pins 3 and 4 after plugging in.

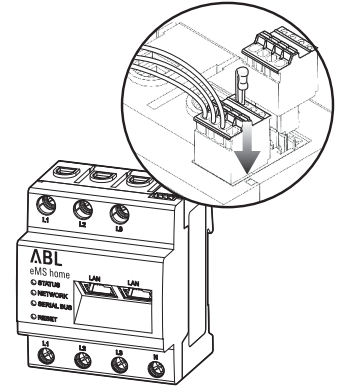

- 4 Cover the eMS home with an electronics cover or the contact protection in the sub-distribution.

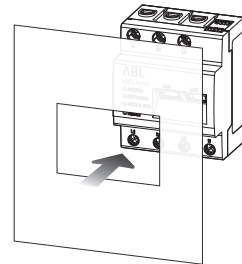

- 5 Connect a network cable to one of the LAN interfaces of the eMS home.

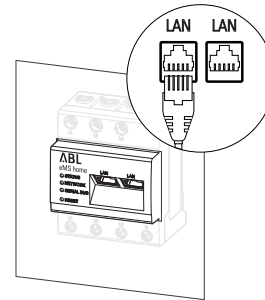

- 6 Connect the other end of the network cable (directly or via a router/switch) to a PC/laptop.

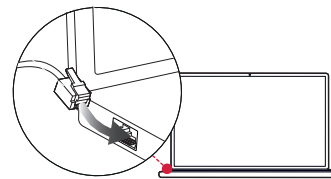

- 7 Reconnect the house connection to the mains.
 - The LEDs on the eMS home will light up during start-up.

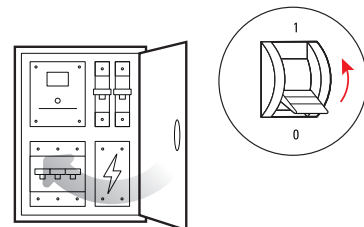

Starting the eMS home web interface

The eMS home is set up via a web interface that is optimised for the current version of the following web browsers:

- Google Chrome
- Mozilla Firefox
- Apple Safari

- Microsoft Edge

It is recommended that you use one of the web browsers mentioned above to ensure a problem-free configuration via the web interface.

NOTE

Limited browser support

Please note that the Microsoft Internet Explorer web browser is not supported.

Log in to the eMS home

- ▶ Enter the IP address of the eMS home in the address bar of the web browser to open the login window. If a DHCP server is active in the network, you can check in the configuration interface of the DHCP server which IP address has been assigned to the MAC address of the eMS home. You will find the MAC address on the rating plate attached to the side of the eMS home as well as on the rating plate included separately in the package (see section on page 7). A DHCP server is integrated as standard in many common router models.

NOTE

Automatic detection in home and workplace networks

On Windows computers, the UPnP service automatically detects the eMS home on the same network and displays it in the network environment. This allows users to find the unit on the network even if they do not know the IP address. To be able to do this, your local network must be set to 'Home network' or 'Work network' but not to 'Public network'.

NOTE

Login via host name

If you want to access the web interface with a Windows computer or iOS device via a router, you can also enter the host name of the eMS home directly in the address bar of the web browser.

- By default, the host name is made up of the prefix "ems-home-" and the serial number of the eMS home (see "Identification of the eMS home" on page 7).
- If necessary, you can change the host name after first logging in by going to **Device Settings > Network Settings** in the web interface.
- The current host name is displayed in the **Device Settings > System Information** section of the web interface.

- ▶ In the login window, enter the factory-assigned password to log in to the eMS home. You will find the password on the rating plate attached to the side of the eMS home or the rating plate included in the package (see page 7).

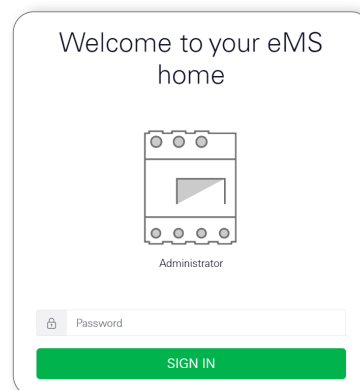

Structure of the web interface

After successfully logging in, the eMS home web interface will appear.

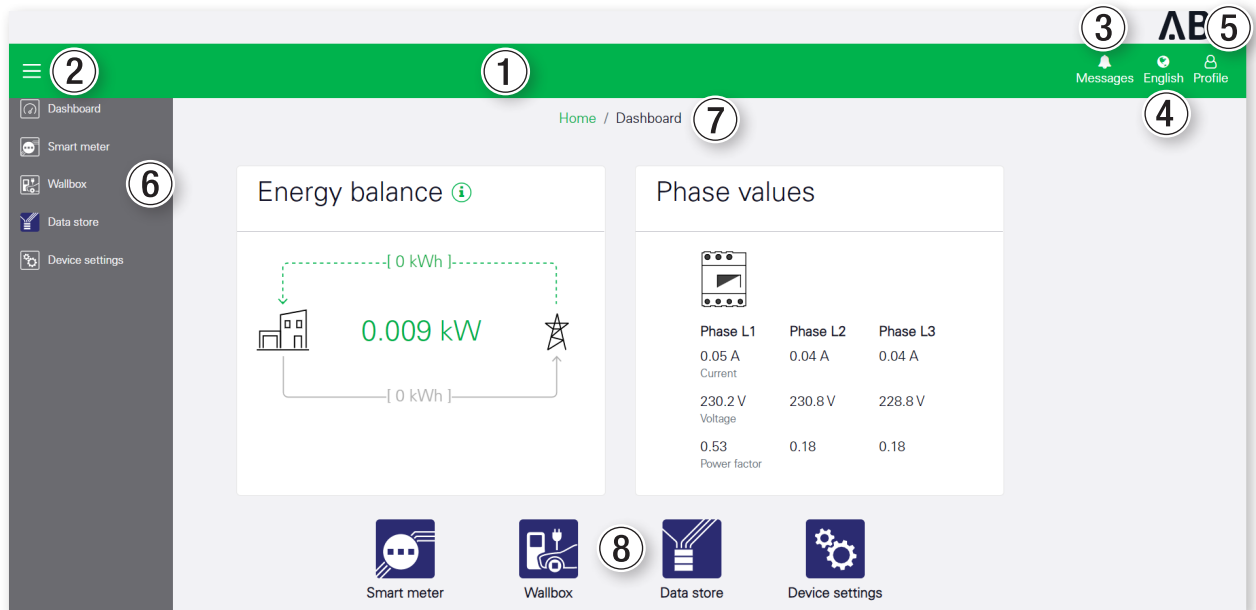

Description

- ① The menu bar is static and is always displayed.
- ② Use this button to show or hide the sidebar.
- ③ Use this button to display all system messages.
- ④ Use this button to select the language for the web interface.
- ⑤ Use this button to open the user profile, with options to log out and change the password.
- ⑥ The sidebar, which can be displayed with ②, provides easy access to all apps. The icon of the active app (in this case: **Dashboard**) is highlighted.
- ⑦ This shows the navigation in the web application menu.
- ⑧ The contents of all apps are displayed here. The dashboard is always displayed automatically after logging in.



NOTE

Shortcut button for navigation

You can return directly to the dashboard at any time by clicking on the ABL button in the top right corner of the web application.

Checking and updating the device firmware

For proper operation, it is recommended to check the internal software (firmware) of the eMS home at regular intervals and update it if necessary. The current firmware is made available via the website www.ablmobility.de/en and is installed via the eMS home web interface.

Proceed as follows:

- 1 Open the website www.ablmobility.de/en and download the file linked in the **Service > All downloads > Software > Firmware eMS home** section to your computer.
 - Unpack the file in a directory of your choice.

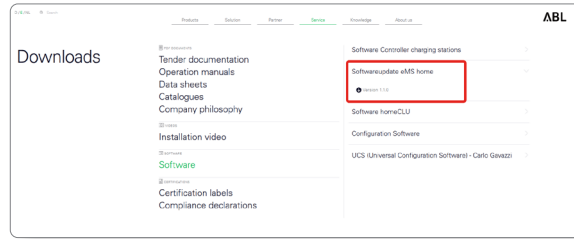

- 2 Switch to the eMS home web interface and click on **Device Settings** in the sidebar or at the bottom of the web interface.

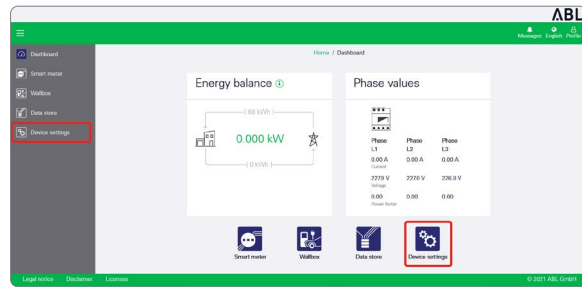

- 3 Navigate to the **System info** section and note the entry in the **Device type** section.
 - The selection of the update file in step 5 depends on the device type noted here.

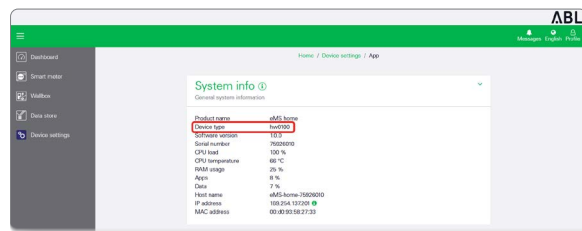

- 4 Navigate to the **Device > Update device firmware** section and click the **Browse** button.

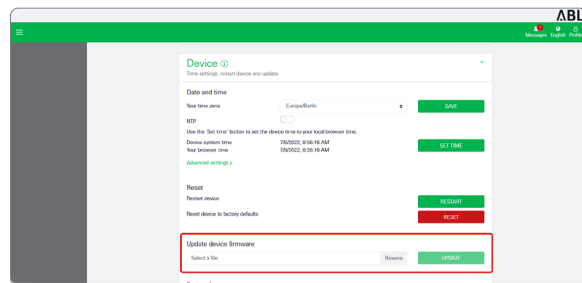

- 5 In the directory with the unpacked ZIP file, select the appropriate update file (**hw0100** or **hw0200**) and click **Open**.

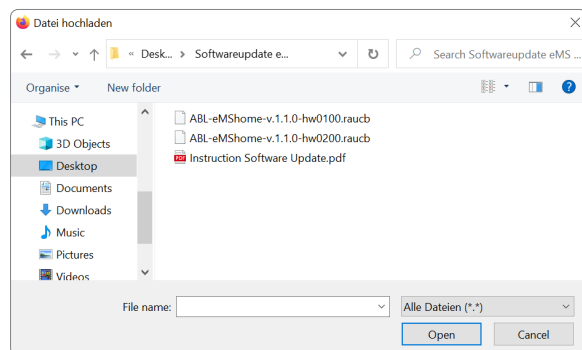

6 In the Device > Update device firmware section, click the Update button.

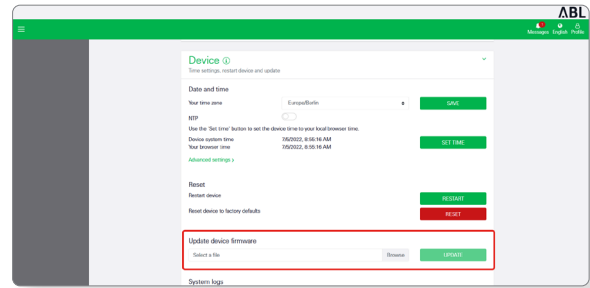

7 The firmware update will be executed, which may take a few minutes.

- During the update process, eMS home is restarted.

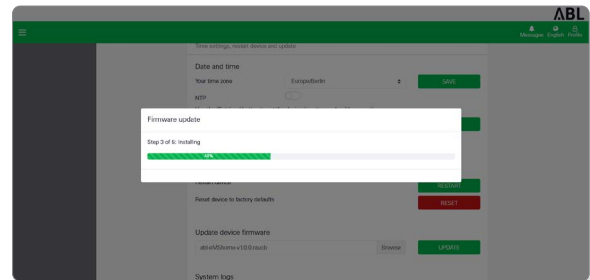

8 After completion, a message about the successful update is displayed in the system messages.

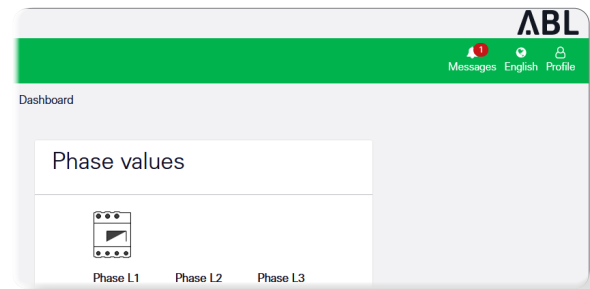

You can then set up the new functions of the eMS home via the web interface.

WARNING!

Manual opening of the web interface in case of problems with automatic re-login

If the web interface was not automatically reloaded after a period of about 5 minutes, the eMS home may have received a new IP address.

- Proceed as described in the section “Log in to the eMS home” on page 21 to open the web interface manually.

Setup via the eMS home web interface

To ensure successful operation, the eMS home requires detailed information on the mains connection and rated current in the installation. For successful communication, you must also register the individual wallboxes on the eMS home.

Proceed as follows:

1 Click the Wallbox button at the bottom of the web interface.

- The Wallbox app will then open.

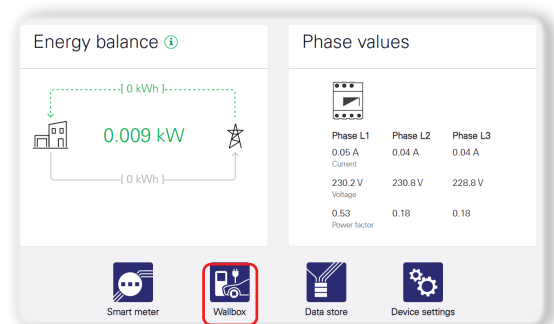

2 Click the **Settings** icon on the right-hand side of the **Wallbox** app.

- The **Available charging devices** page will then open – there will not be any wallboxes entered here yet.

3 First, scroll down to the **Overload protection** section.

4 In the **Overload protection** section, enter the required information about the mains connection and rated current.

- **Type of mains connection:** 1- or 3-phase
- **Rated current phases:** Size of the respective fuse

5 Click the **SAVE** button to save the information in eMS home.

6 Scroll up the page again to the **Available charging devices** section.

- You can now register the wallboxes in the system individually in the eMS home here.

7 Use the drop-down menu to select the option **ABL charging station** and click the **Add** button.

- The **Add ABL charging station** page then opens.

8 Enter the required information about the connected wallbox on the **Add ABL charging station** page.

- **Name:** Freely selectable
- **Modbus Interface:** Interface B
- **Wallbox ID:** Address number specified during setup in the **ABL Configuration Software** (see page 18 onwards).

9 Finally, click **OK** to add the wallbox as a charging device.

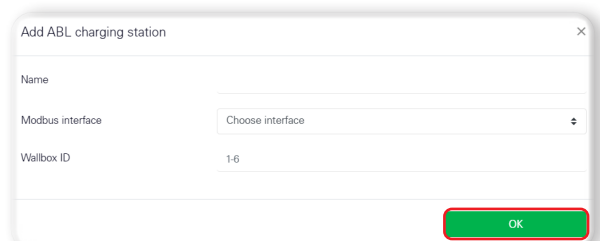
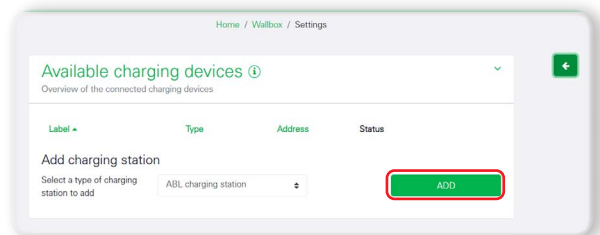
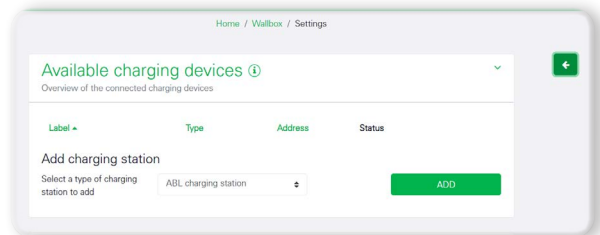
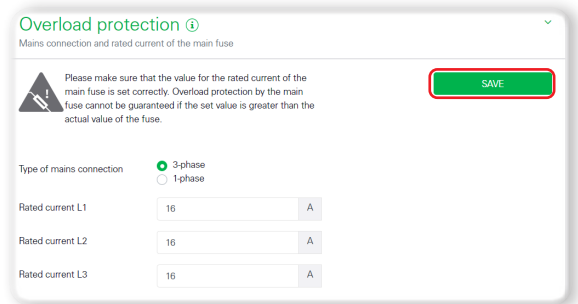
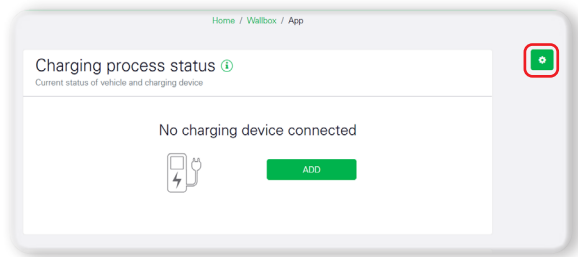

**WARNING!****Adding additional wallboxes as charging devices**

Repeat steps 7 to 9 for each additional wallbox you want to add to the system.

- Make sure the **Wallbox ID** (address number from the **ABL Configuration Software**) is assigned consecutively. Otherwise, faultless communication cannot be guaranteed.

- 10** Use this method to add all wallboxes (up to a maximum of six): If they are shown with a green tick in the **Status** column, communication with the eMS home is set up correctly.

Label	Type	Address	Status
eMH1-1	ABL charging station	RS485 B- 1	✓ i ↗ 🗑️
eMH1-2	ABL charging station	RS485 B- 2	✓ i ↗ 🗑️

Finally, click on the arrow  on the right to exit the **Settings** and return to the **Wallbox** app.

**NOTE****Internal processing of settings**

When you exit the **Settings** menu, an error message may appear for 30 seconds: this is not really an error, but rather the time until the connection is established with the wallbox(es). Therefore, please wait until the error message disappears before continuing.

Description of the individual apps of the eMS home

The dashboard of the eMS home web interface (see below) provides basic information about the system and allows access to individual apps at any time. These are described in more detail in the following sections.

Dashboard

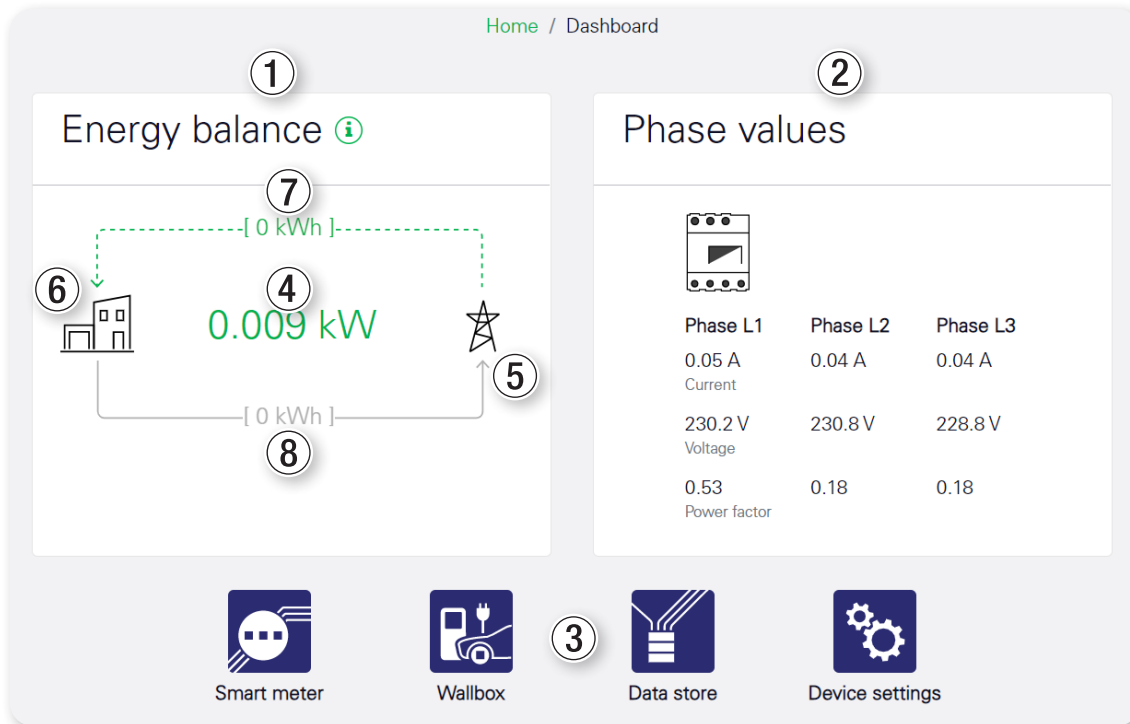

The dashboard contains the **Energy balance** (1) and **Phase values** (2) widgets.

- The value (4) displayed centrally in the **Energy balance** widget shows the current active power in kW.
- The arrows indicate whether the entire system is drawing power or feeding it into the electricity grid: the upper arrow represents the power being drawn, while the lower arrow represents the power being fed in.
- The current state is indicated by a green, dashed arrow: in the illustration above, the system is currently drawing power from the grid (6).
- The inactive state is represented by a grey, solid arrow (5).
- The upper value on the arrow (7) shows the meter reading for the drawn power (active energy in kWh) over the entire operating time. The lower value (8) indicates the meter reading for the power fed in (active energy in kWh) over the entire operating time.
- The **Phase values** widget on the right shows the current measured values for the current, voltage, and power factor for all three outer conductors (L1, L2, L3).

The lower section (3) lists the other available apps, which can be accessed via these buttons and via the sidebar at the touch of a button.

Messages – App Health Check

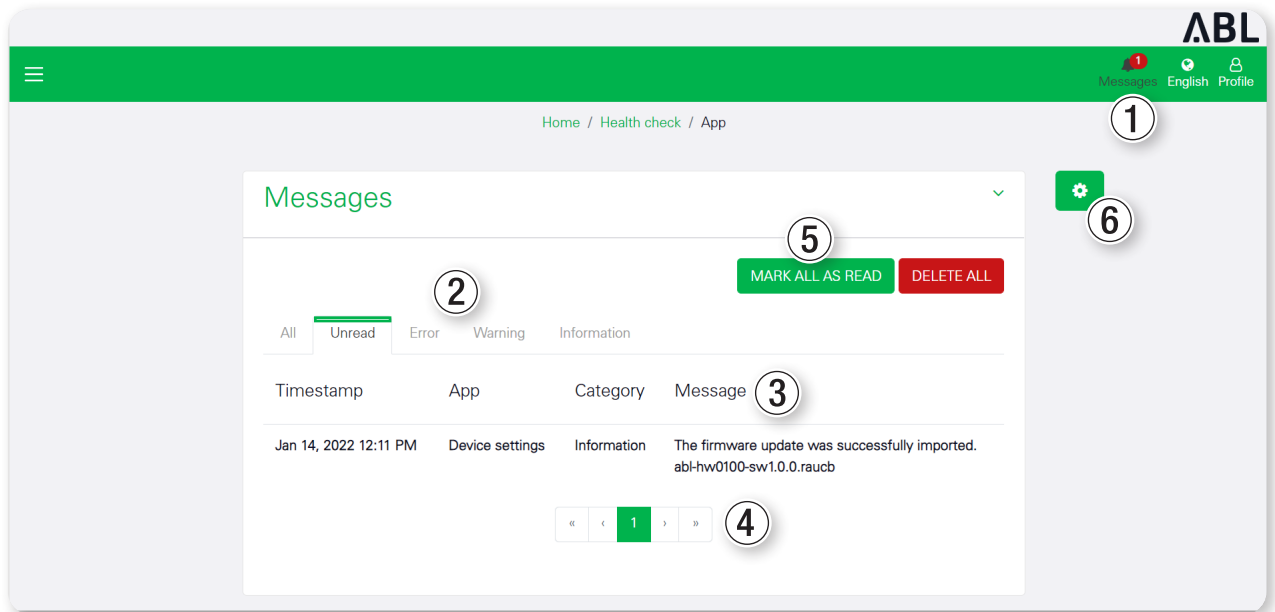

Description

The **Health Check** app centrally manages **Messages** ① that are sent from the apps to the user. If there are any unread messages, the number of unread messages appears in red on the bell icon.

After clicking on **Messages** ①, a table containing the messages is displayed. This table shows the following **Categories** ②, which you can select by clicking on them:

All	All saved messages are displayed.
Unread	Only unread messages are displayed.
Error	Only messages from the Error category are displayed.
Warning	Only messages from the Warning category are displayed.
Information	Only messages from the Information category are displayed.

The current selection is indicated by a green bar.

The table below shows the timestamp of the message, the app that sent the message, the category (**Error**, **Warning** or **Information**) and the message itself ③.

Each page displays up to 10 messages. Below the table is a menu for scrolling through using the left and right arrows as well as page numbers ④. The currently displayed page number is highlighted in green.

A maximum of 1,000 messages can be stored. If this number is exceeded, the oldest messages are deleted.

If there are any unread messages, the **MARK ALL AS READ** button ⑤ appears in the widget. Clicking this button marks all unread messages as read and moves them to the corresponding categories. The button is then hidden. This also resets the number of unread messages on the bell icon.

Settings

Settings for critical system messages ▼ ←

Configure notifications for critical system messages

Configure email notifications

Critical system messages can be sent by email as well as being displayed in the browser. SAVE 4

Email export settings

Here you can start exporting emails.

Enable email export 1

Email address 2 Not configured EDIT

Subject 3 Critical System Notification

The settings for configuring the **Health Check** app can be opened by clicking the button with the gear icon 6.

Email export can be enabled (**Enable email export** 1) once the email settings have been configured in the Device settings (see chapter “Device settings app” on page 43).

The recipient’s **Email address** 2 is displayed at this point for information only.

Clicking on the **EDIT** button opens the corresponding widget in the **Device Settings** app. As an additional option, you can specify a **Subject** 3 for the email. The default is **Critical System Notification**.

Click on **SAVE** 4 to save the current configuration.

Smart Meter app

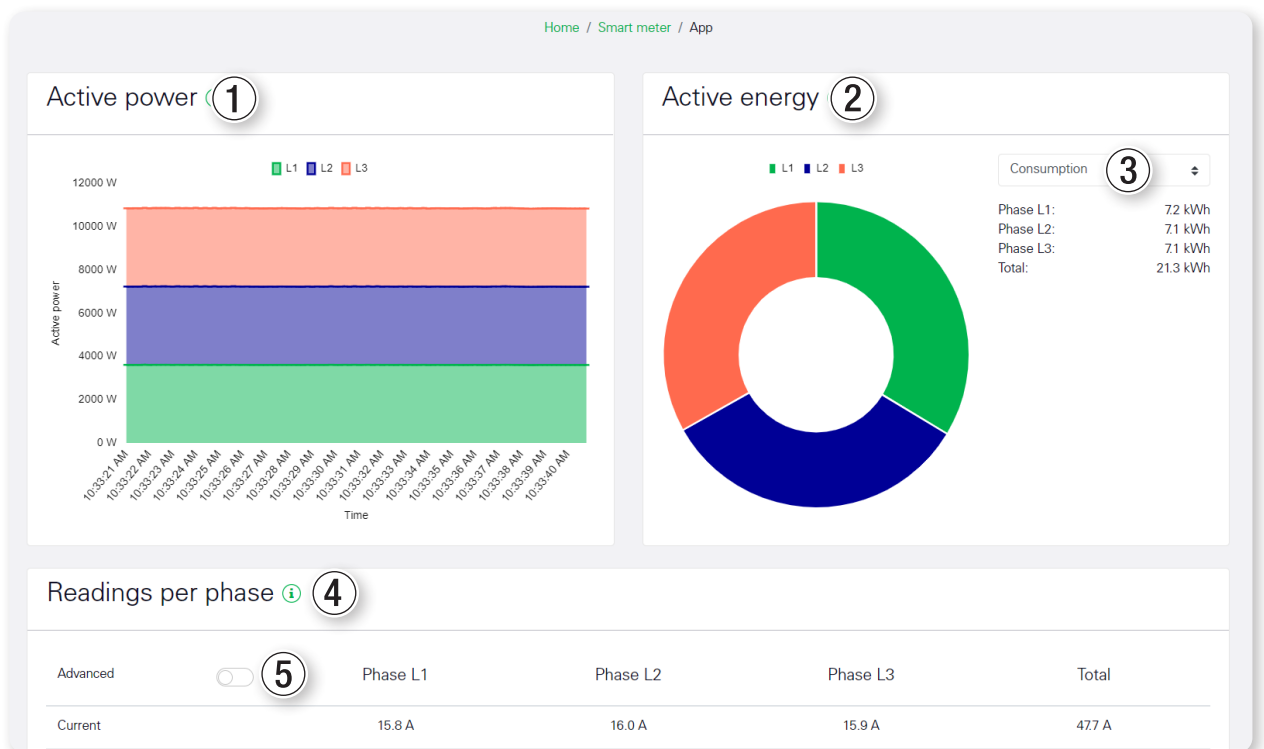

The line diagram shown in the **Active power ①** widget shows a short-term trend of the total active power over the three individual phases. The power values displayed in the app are marked with a (+) when drawing power and a (-) when feeding in power.

The **Active energy ②** widget shows the ratio of active energy between the three phases. The drop-down list ③ can be used to switch between the **Consumption** and **Feed-in** display.

The table in the **Readings per phase ④** widget shows all the physical quantities recorded by the system for the entire system and individually per phase. All power and energy values are shown separately as draw (+) and feed (-).

The **Advanced ⑤** switch displays the values for reactive and apparent power, as well as reactive and apparent energy.

Wallbox app

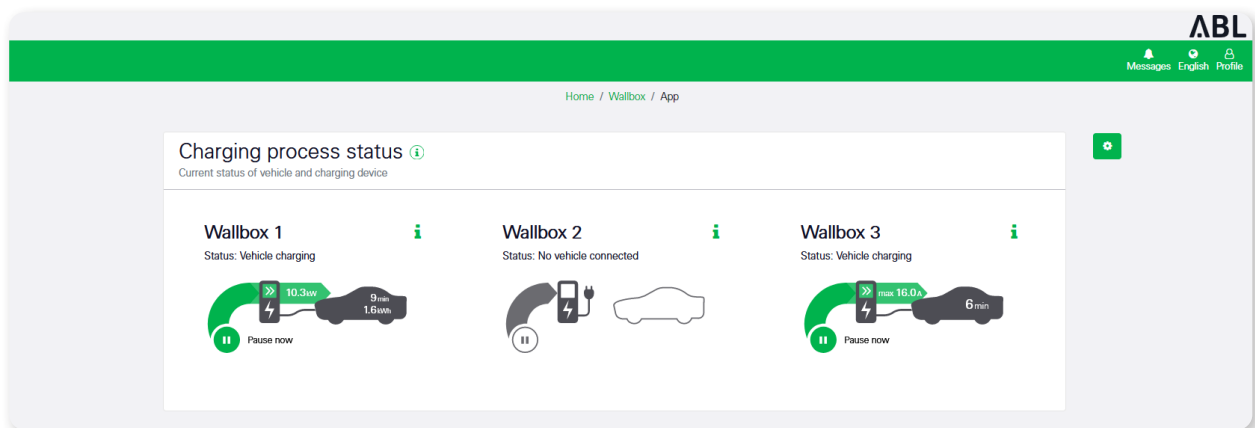

The Wallbox app displays the current status of all connected charging devices.

For each charging device, a graphic is displayed to visualise the status, including a pause button. The name of the charging device and an info button **i**, which opens a detailed view, are displayed above it.

Possible statuses

No charging device connected	No charging device has been set up yet (see "Setup via the eMS home web interface" on page 24).
No vehicle connected	There is no vehicle connected to the charging device. The vehicle is shown in the graphic as an empty silhouette.
Vehicle is charging	The vehicle is being charged. In the graphic, the vehicle is connected to the charging device and an arrow symbolises the energy transfer from the charging device to the vehicle. The current values for the charging power as well as the duration and charged energy of this charging process are displayed.
Charging process paused	The vehicle is connected to the charging device, but the charging process has been stopped. The charger contains a pause symbol and the energy transfer arrow is greyed out. Depending on the wallbox variant, the current values for the charging power as well as the duration and charged energy of this charging process are displayed.
Charging disabled by external specification	The charging process was paused by an external factor (e.g., the wallbox was locked manually). Charging is not possible.
Charging process paused due to internal control	The charging process was paused by an internal control (e.g., in "PV surplus charging" mode, there is insufficient surplus available from the PV system).
Initialising charging process	At the start of each charging process, an initialisation takes place in order to identify certain parameters of the charging process. Meanwhile, all other charging vehicles are reduced to their minimum charging current. In the graphic, the vehicle is connected to the charging device and two circular arrows are displayed.
Communication error	There is no connection to the charging device. The charging device is greyed out and a warning symbol is displayed.
Error in charging device	The charging device reports an error. The vehicle is greyed out and a warning symbol is displayed.

Detailed view

Wallbox 1
✕

Status

Vehicle charging

Current charging process

Duration:	8 min
Maximum current:	170 A
Minimum current:	6.0 A
Charged energy:	1.2 kWh

Charging current per phase

Phase L1:	16.0 A
Phase L2:	15.7 A
Phase L3:	15.9 A

OK

! **NOTE**

Limited monitoring for different wallbox variants

Different wallbox variants only allow limited monitoring of the charging process. In this case, neither the energy value nor the present charging current per phase is displayed, only the maximum default value that the vehicle can draw.

Under certain circumstances, however, the vehicle may charge on its own with a lower amperage.

For each connected charging device, a detailed view can be opened by clicking on the info button *i*. There are three sections here:

Status	The status of the charging device is specified here in text form.
Current charging process	The measured values for the current charging process are displayed here: <ul style="list-style-type: none"> ■ The duration indicates how long the current charging process has been active. ■ Maximum current and Minimum current indicate the maximum and minimum possible charging current per phase of the vehicle. These values depend on the connected vehicle and are determined during the initialisation phase. ■ Charged energy indicates how much energy in kWh has already been charged during the current charging process.
Charging current per phase	The current charging current per phase is broken down here.

Wallbox charging mode

The Wallbox charging mode card allows you to select where the electricity for charging the electric vehicles is to be obtained from.

If **Don't charge** is selected, no connected vehicle is being charged.

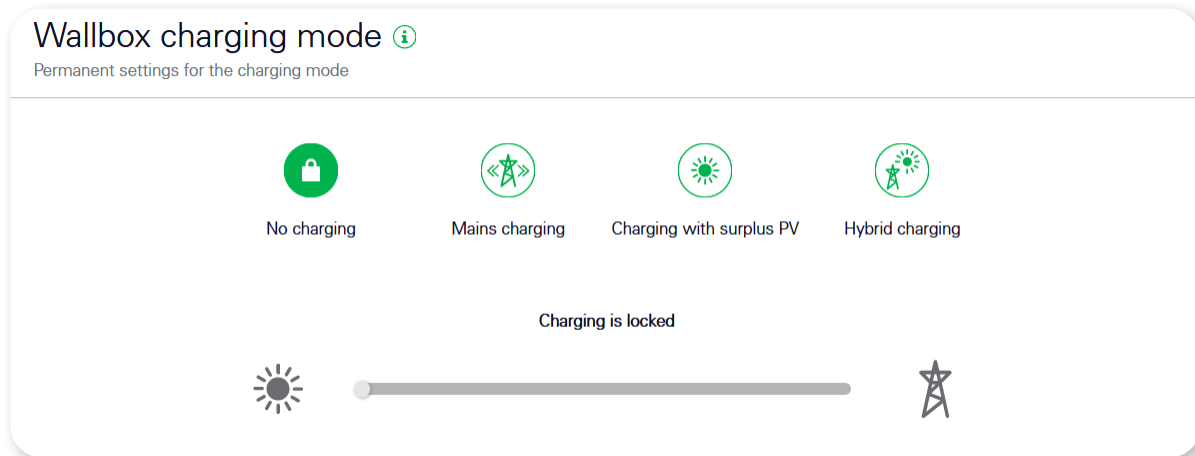

- If **Mains charging** is selected, the vehicle is being charged at all times, regardless of whether photovoltaic power is available or the current is drawn from the grid. Select this mode if no photovoltaic system is available or if the vehicle is to be fully charged by a certain time in the near future.

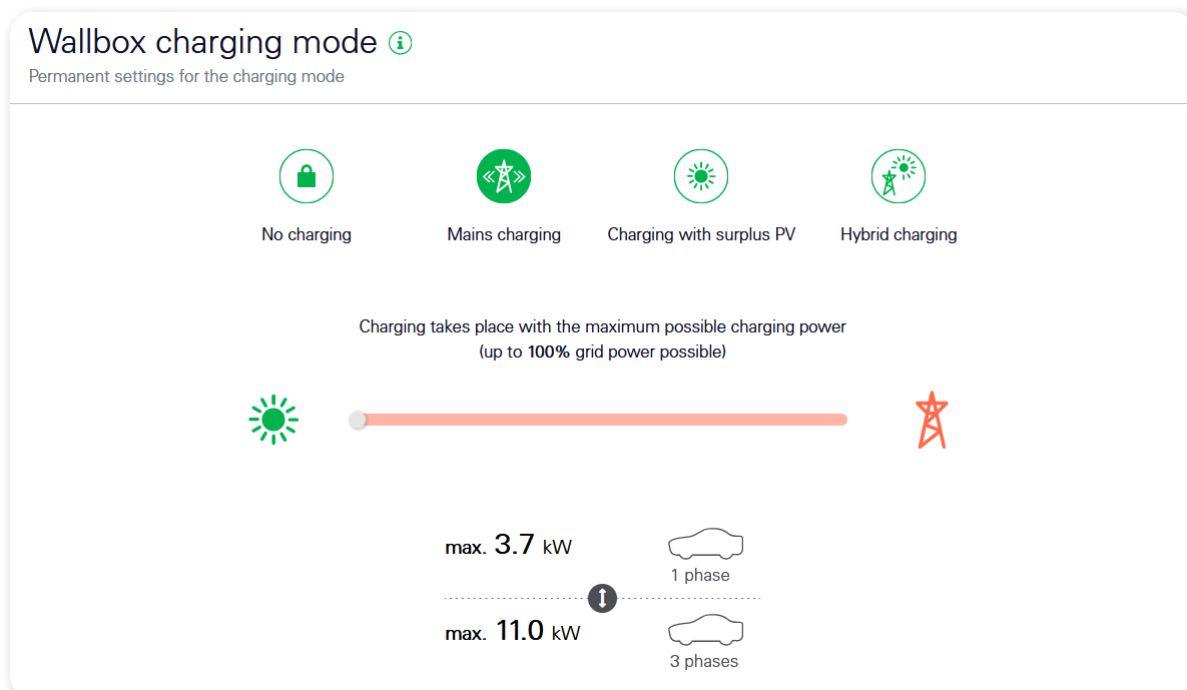

- If **Charging with surplus PV** is selected, the vehicle is only charged when electricity produced in the house itself – typically photovoltaic electricity – is available, which would otherwise be fed into the grid. This mode can be used to increase the self-consumption of the electricity produced. However, the charging process may take considerably longer, as for example, sufficient solar radiation must be maintained. Select this mode when a lot of photovoltaic power is expected and there is enough time to fully charge the vehicle.

Wallbox charging mode (i)

Permanent settings for the charging mode



No charging



Mains charging





Charging with surplus PV



Hybrid charging

Selected minimal power of 100% by solar energy of charging power
(up to 0% grid power possible)



min. 1.4 kW  1 phase

min. 4.1 kW  3 phases



NOTE

Stabilisation of the charging current

In order to stabilise the control system and to compensate for fluctuations in the charging current produced, additional current is drawn from the grid if required.

- If **Hybrid Charging** is selected, you can use the slider below it to specify a minimum share for the surplus energy that must be provided by the PV system in order for the charging process to start. In practice, you must select the ratio between the PV surplus and the mains current in such a way that the minimum current per phase, from which your vehicle issues a charging request, is achieved in any case.
 - If the desired proportion of solar energy is set too high, the minimum current (see figure below) may not be reached and no charging will take place.
 - When the desired proportion of solar energy is reached, the charging request by the vehicle can be served to the desired proportion with the surplus energy of the PV system, while the remaining demand is drawn from the mains.
 - If the PV system provides significantly more surplus energy, the drawn energy can be used up to the maximum value of 100 percent for the charging process. In this case, the share of energy drawn from the grid decreases proportionally.

Wallbox charging mode i

Permanent settings for the charging mode



No charging



Mains charging





Charging with surplus PV



Hybrid charging

Selected minimal power of 40% by solar energy of charging power
(up to 60% grid power possible)



min. 0.6 kW	+	min. 0.8 kW	=	min. 1.4 kW	 1 phase
----- ⓘ -----					
min. 1.7 kW	+	min. 2.4 kW	=	min. 4.1 kW	 3 phases

- **Hybrid Charging** mode is recommended for sustainable charging with small PV systems that provide comparatively little surplus energy. It can therefore take a relatively long time until the vehicle is sufficiently charged.

! NOTE

Definition of PV surplus

The percentage for PV surplus is the minimum value, while the grid supply is the maximum value. When set accordingly, the PV surplus share can therefore increase to up to 100% (pure surplus charging).

Total charging power

The **Total charging power** card gives an overview of the power available for charging and the power retrieved. In this view, the current total charging power of all configured charging devices is shown in kW and also as a colour-

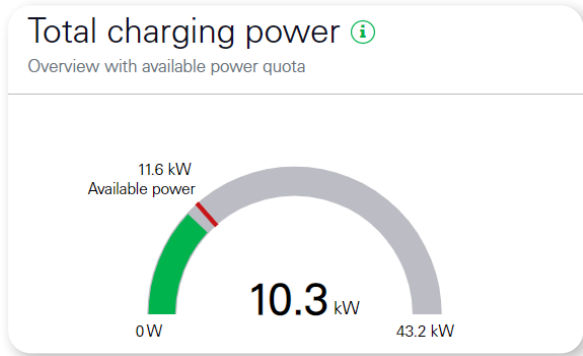

ed bar on a grey background.

The red line on the bar graph shows the maximum available power given to the charging devices. The total charging power therefore cannot exceed this value.

However, it may be the case that the charging devices do not make full use of the available power. The value at the bottom right of the screen is the maximum power that would be possible from the configured fuses if all three phases were fully utilised. This is therefore a theoretical maximum, which is not achieved in regular operation.

Phase load

The **Phase load** card shows the present measured values for current at the mains connection point and thus refers to the entire house. The present phase current is compared with the configured fuse.

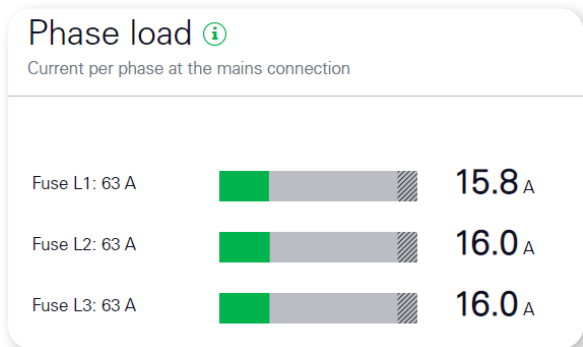

For each phase, the present phase current is displayed as a coloured bar on a grey background. The hatched area on the right-hand side corresponds to a proportion of >90% of the set phase fuse.

When the phase current reaches this range, it is displayed in red. From this point, the overload protection limits the respective charging processes, so that the limit is maintained again.

Settings > Available charging devices

The **Available charging devices** card displays all the configured charging devices in a table. It is also possible to add a new charging device here.

Available charging devices ⓘ ▼

Overview of the connected charging devices

Label ▲	Type	Address	Status				
eMH1-1	ABL charging station	RS485 B- 1	✓	ⓘ	✎	🗑️	
eMH1-2	ABL charging station	RS485 B- 2	✓	ⓘ	✎	🗑️	
eMH1-3	ABL charging station	RS485 B- 3	✓	ⓘ	✎	🗑️	
eMH1-4	ABL charging station	RS485 B- 4	✓	ⓘ	✎	🗑️	
eMH1-5	ABL charging station	RS485 B- 5	✓	ⓘ	✎	🗑️	
eMH1-6	ABL charging station	RS485 B- 6	⚠️	ⓘ	✎	🗑️	

The configured charging devices, their configuration and their status are displayed in the table overview. Use the arrow icons in the header to sort the table by **Label**, **Type** or **Address**.

Label	The configured name of the charging device is displayed here.
Type	The type (ABL charging device) is displayed here.
Address	The configured Wallbox ID of the charging device is displayed here.
Status	<p>The current status of the charging device is displayed here by means of the following states:</p> <ul style="list-style-type: none"> ■ The OK (tick) symbol indicates that communication with the charging device is working properly. ■ The Error (!) symbol indicates that communication with the charging device is interrupted.
Info (i)	<p>Clicking on the info symbol opens a window in which additional information such as the serial number, model and firmware version of the charging device is retrieved and displayed.</p> <ul style="list-style-type: none"> ■ While the information is being retrieved from the charging device, a charging indicator appears. ■ If the charging device cannot be reached, the following message appears: An error occurred while establishing a connection to the charging device. <p>Click OK to close the window again.</p>
Edit (pencil icon)	The Edit icon can be used to change the configuration of a connected charging device.
Delete (bin icon)	The Bin icon can be used to remove a charging device.

Adding an ABL charging device

The dialogue for adding an ABL charging device contains an input field for a name of your choice (1-20 characters), a menu for selecting the Modbus interface (RS485 A or RS485 B) and an input field for the Wallbox ID of the charging device (1-6). Click **OK** to save the settings.

- If communication with the new charging device is successful, a green pop-up appears at the top of the page (message: **Changes applied**).
- If communication with the new charging device fails, a red pop-up appears at the top of the page (message: **An error occurred while establishing a connection to the charging device**).

Editing an ABL charging device

In this window, you can change the configuration of an ABL charging device. Both the name and the Modbus settings (Modbus interface and Wallbox ID) can be changed.

Click **OK** to save the changes and close the window.

Deleting an ABL charging device

The window for deleting an ABL charging device contains a prompt to confirm whether you really want to delete the charging device.

- Click **Yes** to delete the charging device.
- Click **No** to close the window without deleting the charging device.

View details of an ABL charging device

This window retrieves and displays additional information such as the serial number, hardware revision and firmware version of the charging device.

If the charging device cannot be reached, the following message appears: **An error occurred while establishing a connection to the charging device**.

Click **OK** to close the window again.

Overload protection

The overload protection prevents the main fuse becoming overloaded by limiting the charging processes of electric vehicles whenever other consumers are already causing high power consumption. To this end, you can set the properties of the main fuse on this card.

Overload protection ⓘ

Mains connection and rated current of the main fuse

Please make sure that the value for the rated current of the main fuse is set correctly. Overload protection by the main fuse cannot be guaranteed if the set value is greater than the actual value of the fuse.

SAVE

Type of mains connection 3-phase 1-phase

Rated current L1 A

Rated current L2 A

Rated current L3 A

- Under **Type of mains connection**, you should specify whether the house connection is single-phase or three-phase.
- The rated current for the individual phases of the main fuse can be entered in amps under **Rated current L1**, **Rated current L2** and **Rated current L3**. This value can be between 1A and 10,000A. If a single-phase mains connection is selected, only **Rated current L1** can be configured.

**WARNING!****Correctly specifying the rated currents**

Correctly specifying the rated currents is essential for the overload protection to function properly. If the set values are less than the actual value of the fuse, charging cannot be carried out with the maximum available current. If the set values are greater than the actual value of the fuse, there can be no guaranteed protection against overload of the main fuse.

Data store app

Home / Data store / App

Energy data ⓘ

View stored energy data

Date	Consumption OBIS: 1-0:1.8.0*255	Feed-in OBIS: 1-0:2.8.0*255
No data available		

Manual data export ⓘ

10:47
 11:47

Here you can download your data in CSV format in a compressed ZIP file.

Description

The **Data store** app allows for continuous storage and display of all the energy and performance values of the eMS home at various intervals and is enabled by default.

- In addition, the minimum, maximum and average values are determined for the performance values and stored for the respective intervals.
- Furthermore, the recorded data can be exported manually or automatically as a CSV file.

**NOTE****Description of the CSV file contents**

The contents of the CSV file are described in detail in the section "Data Storage app – CSV export format" on page 58.

Energy data

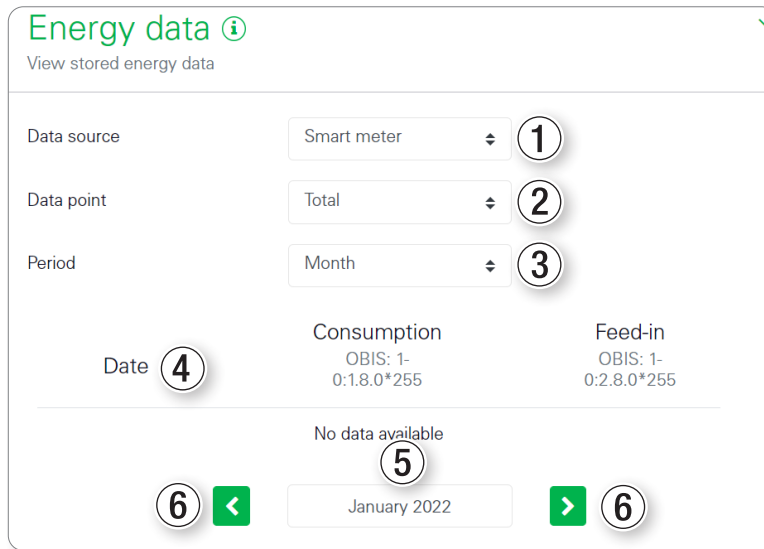

The **Energy data** widget displays a selection of energy values for consumption and feed-in with the corresponding OBIS code on a daily basis.

Data source

The following **Data sources** (1) are available for selection:

- Smart meter
- Sensors (this feature is not currently supported)
- Groups (this feature is not currently supported)

It is recommended that the **Smart meter** setting is always selected.

Data point

Data points (2) for **Total**, **Phase L1**, **Phase L2** and **Phase L3** are available to select for consumption and feed-in.

Each sensor only provides the measured values of one phase. The correct phase must therefore first be selected in order to read the measured values of the sensor. The values of the other phases and the total values are empty.

Period

The daily values of the set month or the monthly values of the set year can be displayed for the selected **Period** (3).

Data table

The table (4) shows the columns for **Date**, **Consumption** and **Feed-in**, as long as data is available. The date is formatted according to the set language. The energy values are displayed rounded to two decimal places in kWh.

Date selector

Depending on the selected time period, the date selector (5) will display either the **month** followed by the **year** or only the **year**. You can use the date selector to select and display a specific year or month directly.

Navigation arrow keys

You can use the arrow keys (6) next to the date selector to select the previous period (back button) or next period (forwards button).

Manual data export

Manual data export ⓘ
▼

① From

January 11, 2022

08:35

② To

January 11, 2022

09:35

③ Resolution

1 minute

Here you can download your data in CSV format in a compressed ZIP file.

④ MANUAL DATA EXPORT

The **Manual data export** widget allows the saved data of the eMS home, including the values for the sensors, to be exported from the database to a CSV file.

The time **Resolution** ③ of the exported values is determined by the selected time period, which is defined with the fields **From** ① and **To** ②, based on the following specifications:

Selected period	Selectable resolution of the value intervals
≤ 1 day	1 minute, 15 minutes, 1 day
≤ 14 days	15 minutes, 1 day
> 14 days	1 day

After making your selection, the download can be started by clicking the **Manual data export** button.

Settings

The settings for recording and exporting the data can be reached by clicking the button with the gear icon ①.

General settings

General settings ⓘ
▼

General settings for the data store

Logging

Data acquisition can be switched on and off manually.

Enable data logging ①

② SAVE

The data storage can be switched on or off using the **Enable data logging** switch ①. Click on the **SAVE** ② button to apply the changes.

If data storage is switched off, exporting the data via FTP and email is also stopped.

Export settings

The **Export settings** widget can be used to configure the automatic export of stored energy values in CSV format.

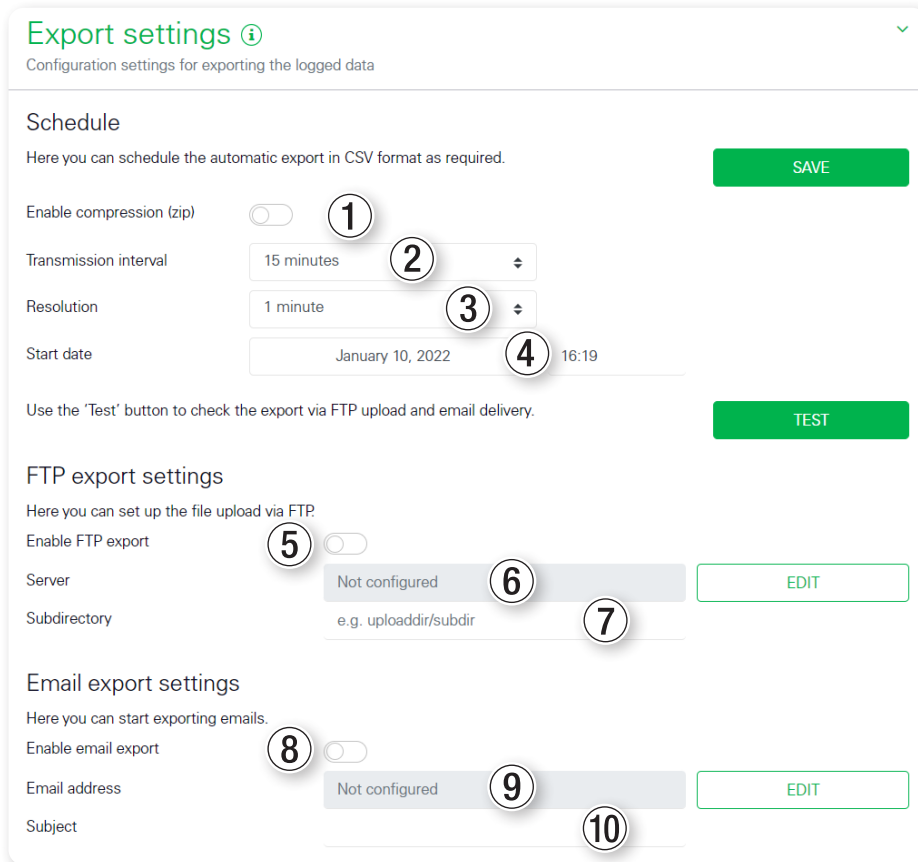

Schedule

In the **Schedule** section, you can select the **Transmission interval** (2) and the **Resolution** (3) of the exported file. The resolution can be selected depending on the selected send interval:

Transmission interval	Choice of resolution
15 minutes	1 minute
Hour	1 minute, 15 minutes
Day	1 minute, 15 minutes, day
Week	15 minutes, day
Month	Day
Year	Day

In addition, a **Start date** (2) can be selected for the start of the automatic export.

If necessary, the exported data can be compressed as a ZIP file using the option **Enable compression (zip)** (1).

FTP export settings

FTP export can be enabled (**Enable FTP export** (5)) once an FTP server has been configured in the Device settings (see chapter "Device settings app" on page 43). The **Server** name (6) is displayed at this point for information only. Clicking on the **Edit** button opens the corresponding widget in the **Device Settings** app.

As an additional option, you can specify a path for saving the data on the FTP server in the **Subdirectory** (7) field.

Email export settings

Email export can be enabled (**Enable email export** ⑧) once the Email settings have been configured in the Device settings (see chapter “Device settings app” on page 43).

The **Email address** of the recipient ⑨ is displayed at this point for information only. Clicking on the **Edit** button opens the corresponding widget in the **Device Settings** app.

As an additional option, you can specify a **Subject** ⑩ for the email. The default is **Energy Manager: Automatic Export – Data Storage**.

Device settings app

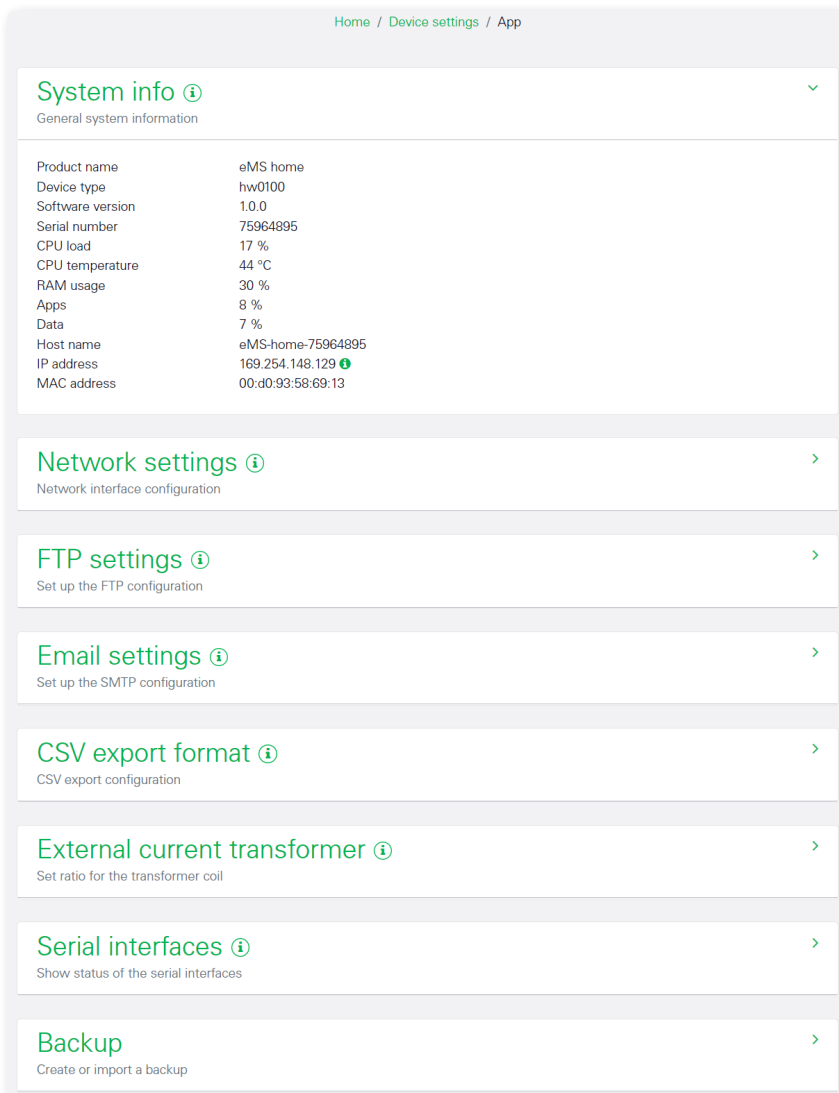

You can do the following in the **Device settings** app:

- Show eMS home system information
- Configure network, FTP, email, and CSV export
- Configure external current transformers and serial interfaces
- Create and import backups of eMS home
- Configure date and time, reboot or reset eMS home, update firmware, view system logs

System info

System info ⓘ

General system information

Product name	eMS home
Device type	hw0100
Software version	1.0.0
Serial number	75964895
CPU load	99 %
CPU temperature	49 °C
RAM usage	26 %
Apps	8 %
Data	7 %
Host name	eMS-home-75964895
IP address	169.254.148.129 ⓘ ①
MAC address	00:d0:93:58:69:13

This widget contains general system information and information about the current status of the eMS home. The following details are displayed:

- Product name
- Installed firmware version
- Serial number of the eMS home
- Current CPU load
- Current CPU temperature
- Current RAM usage
- Used space of the app partition
- Used space of the data partition
- Host name
- IP address
- MAC address

By clicking on the ⓘ ⓘ icon next to the IP address, you can access more detailed information about the network settings. The associated widget also displays the current subnet mask, default gateway, and DNS server.

Network settings

Network settings ⓘ
▼

Network interface configuration

You can make changes to the IP settings here. Please note that you may not be able to access the user interface if the settings are incorrect.

SAVE

Host name	①	eMS-home-75964894
DHCP	②	<input checked="" type="checkbox"/>
IP address		_____
Subnet mask		255.255.255.0
Default gateway		_____
DNS server	③	_____

Enable the UPnP service in order to locate the device in the Windows network environment.

Note: For the UPnP service to work, your Windows network location must be set to 'Home network' or 'Work network' but not to 'Public network'.

UPnP

④

The **Network settings** widget provides access to all the configuration settings required to integrate the eMS home into the local network.

The **Host name** ① is the unique name of the eMS home in the network. It can be freely selected and can contain upper-case and lower-case letters, numbers and hyphens.

When **DHCP** ② is enabled, the eMS home automatically obtains an IP address, for example, from a router. No further settings are necessary.

If a static IP address is to be set, DHCP must be deactivated using the switch. A static IP, subnet mask, default gateway, and the **DNS server** ③ can then be configured.

When **UPnP** ④ is enabled, the eMS home is automatically detected by Windows computers on the same network and displayed in the network environment. This allows users to find the eMS home on the network even if they do not know the IP address.

FTP settings

FTP settings ⓘ
Set up the FTP configuration

Here you can configure the connection to a specific FTP server. **2** SAVE

Protocol: FTP Passive mode

Server: _____

Port: **1** 0

User name: _____

Password: *****

When you change the FTP connection, we recommend that you test it. Use the Test button to check the FTP connection to the configured FTP server. **3** TEST

Reset the FTP configuration. **4** RESET

In this widget, settings for using FTP can be changed. The following configuration fields are shown **1**:

- **Protocol:** Choice between FTP and SFTP, activation of **Passive mode**
- **Server:** Address or IP of the FTP server
- **Port:** FTP server port
- **Username:** Username for logging in to the FTP server. The username must contain at least 3 letters.
- **Password:** Password for logging in to the FTP server

Click on **SAVE** **2** to save the settings.

Click on **TEST** **3** to test the FTP connection. To do this, the FTP configuration must first be saved. Either a green success message (**Connection test successful**) or a warning (**Connection test failed**) and an error message appears under the **TEST** button.

Click **RESET** **4** to delete the FTP settings again.

Email settings

Email settings ⓘ
✓

Set up the SMTP configuration

Here you can configure a connection to an SMTP server if you want to be notified of various events by email. ② **SAVE**

Email address

SMTP server

Port ①

Use encrypted connection (TLS)

The server requires authentication

User name

Password

When you change the SMTP configuration, we recommend that you test it. Use the Test button to send a test email to the configured email address. ③ **TEST**

Reset SMTP configuration. ④ **RESET**

In this widget, settings for sending emails can be changed. The following configuration fields are shown ①:

- **Email address:** Email recipient
- **SMTP server:** SMTP server that sends the emails
- **Port:** SMTP server port
- **Use encrypted connection (TLS):** Setting to specify whether TLS is to be used to connect to the SMTP server
- **The server requires authentication:** Setting to specify whether authentication is required to connect to the SMTP server
- **User name:** Username for logging in to the SMTP server. Only necessary if the **The server requires authentication** option is activated
- **Password:** Password for logging in to the SMTP server. Only necessary if the **The server requires authentication** option is activated

Click on **SAVE** ② to save the settings.

Click on **TEST** ③ to send a test email. To do this, the email configuration must first be saved. Either a green success message (**The test email was successfully delivered to your provider.**) or a warning with an error message (**Email could not be delivered.**) appears under the **TEST** button.

! NOTE

Note on setting up email settings

To set up the email settings correctly, an external app password for your email account may be required from your provider. To set up an external app password, please contact your provider.

The following providers are supported:

- Gmail
- GMX
- Web.de
- T-Online.de
- AOL

Support for other providers may vary. Please contact your provider for information on how to connect the eMS home. Whether or not authentication is required for connection to the company's own email server depends on the configuration.

Click **RESET** ④ to delete the email settings again.

CSV export format

In this widget, settings for the format of exported CSV files can be changed:

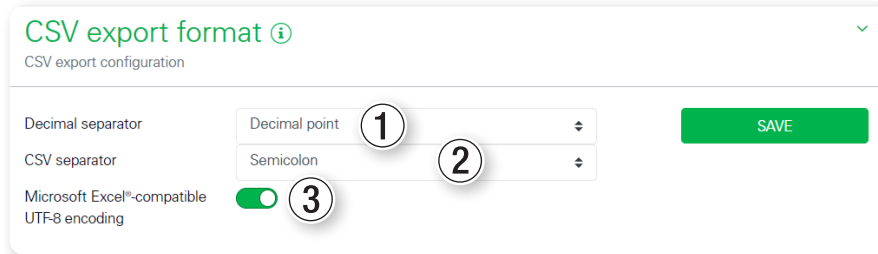

- **Decimal separator:** Separator used in decimal numbers. You can choose between a **Decimal point** and a **Comma**.
- **CSV separator:** Separator between the fields in the CSV file. You can choose between a **Comma**, **Semicolon** and a **Tabulator**.
- **Microsoft Excel®-compatible UTF-8 encoding:** This setting ensures that umlauts and special characters are displayed correctly after importing into Microsoft Excel®.

External current transformer

The eMS home can directly measure up to 63 A per phase conductor. External current transformers are required for higher currents. If the system is connected to a current transformer, the connection can be set up in this widget.

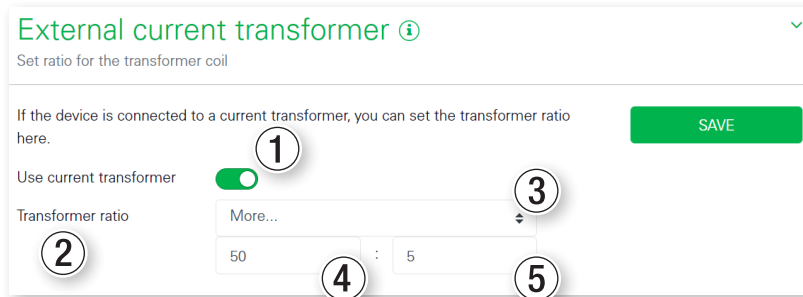

To do this, **Use current transformer** ① must be activated and the **Transformer ratio** ② set. Common transformer ratios are specified in the drop-down list. If the ratio is not included in the list, the desired ratio can be entered manually in the drop-down list using **Other** ③. The **Primary current** ④ may be in the range of 1 to 5,000 and the **Secondary current** ⑤ in the range of 1 to 5 (recommended: 5 A secondary, accuracy class 1).

Serial interfaces

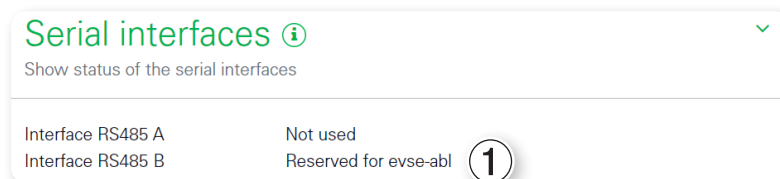

This widget displays status information about the serial ports. These can be either free or occupied by a specific app, whose name ① is shown here. Further configuration of the serial interface is done in the specified app.

Backup

Backup
Create or import a backup

Create a backup
Create a password-protected backup to save your data and settings. **CREATE** ①

Import a backup
Select the backup ② **IMPORT** ③

Create a backup

Clicking **CREATE** ① opens a widget that can be used to create a backup of the system settings and collected data. You have the option to enter a password in the **Password** field to protect the data backup.

Please note the following information in the widget:

WARNING: The system does not perform any measurements while the backup is being created. This will result in gaps in data recording and a temporary interruption of communication on any data interfaces.

The backup process is started by clicking **CREATE** ①. After the backup process has been completed, a backup file (**Backup.bak**) is made available to download in the browser.

Import a backup

To import a backup, a local backup file must first be selected via the **Select the backup** ② input field. Clicking **IMPORT** ③ opens the **Import a backup** widget. In this widget you can enter the password for the backup file (if assigned). Clicking **IMPORT** ③ starts the import of the backup.

Please note the following information in the widget:

WARNING: The system is being restored. All data and configurations will be reset to the status at the time of the backup creation. Any data and configurations generated after this will be lost.

After the backup has been successfully imported, the eMS home will restart.

Device

General settings can be changed in this widget.

Date and time ①

It is important to always set the **Time zone** so that factors such as date limits or summer/winter time in the local time zone are correctly taken into account by the system.

If the system is not connected to the Internet or you do not want to use automatic time synchronisation, there is the option to set the time manually. To do this, the user interface displays the current system time of the eMS home (adjusted to the local time zone) along with the current browser time. Click **SET TIME** to synchronise these two times. The browser time is automatically converted to UTC and set as the system time of the eMS home.

- **Your time zone:** Under the **Your time zone** drop-down list, there is a list of time zones you can set for the system.
- **NTP:** If the system is permanently connected to the Internet via the network, it is recommended to activate the NTP option. This automatically obtains the time from the Internet via a server.
- **Device system time:** The date and time of the eMS home can be set here. The system runs internally on UTC only, which is converted to the local time zone for display.
- **Advanced settings:** An alternative NTP server can be configured under **Advanced Settings**. The system uses the Google time server (time.google.com) by default.

Reset > Restart device ②

Click on **RESET** and then confirm with **YES** to restart the device. This may take several minutes. The web interface is then automatically reloaded.

Reset device to factory defaults ③

Click on **RESET** and then confirm with **YES** to reset the device to the factory settings. All measurement data and settings are then permanently deleted. After the device has been reset to the factory settings and restarted, you will need to log in again with the factory password for the web interface (see section "Starting the eMS home web

interface” on page 20). The factory password can be read from the rating plate label attached to the side of the device as well as the separate rating plate label included in the package.

Update device firmware ④

A new device firmware can be installed in this area. To do this, first select the update file and then click **UPDATE**. After a confirmation prompt, the new firmware is uploaded, installed and the eMS home is restarted.

This process may take several minutes. The web interface is then automatically reloaded.

To do this, please also refer to the section on “Checking and updating the device firmware” on page 22.

System logs ⑤

In this area, the log files can be downloaded as a text file for different periods of time. It may take a few minutes to create the logs, during which no further logs can be downloaded.

Appendix

Technical specifications

General

Interfaces	2 × LAN (10/100 Mbit) 2 × RS485 (half-duplex, max. 115200 baud)
Class of protection	II
IP rating	IP2X
Connection cross section in line with EN 60204	10 – 25 mm ² * *Mechanical: 1.5–25 mm ² (e.g. for connecting external current transformers)
Tightening torque for screw terminals	2.0 Nm
Weight	0.3 kg
Dimensions	88 × 70 × 65 mm
Ambient temperature in operation	-25 °C...+45 °C
with reduced measuring current I_N at 32 A	-25 °C...+55 °C
Ambient temperature during transportation / storage	-25 °C...+70 °C
Relative humidity (non-condensing)	Up to 75 % as an annual average, up to 95 % on up to 30 days/year
Max. altitude during operation	2000 m above sea level

Mains power supply

Starting current	< 25 mA
Supply voltage / frequency	110 V AC ±10 % / 60 Hz ±5 % or 230 V AC ±10 % / 50 Hz ±5 %
Internal consumption P_{max}	5.0 W

Measuring current circuit for measurement category III

Limit current I_N / outer conductor	63 A
Rated voltage	max. 230/400 V AC
Frequency range	50/60 Hz ± 5 %

Operation of the eMS home at an ambient temperature of 55 °C

The following conditions apply to operation of the Energy Management System at ambient temperatures up to 55 °C:

- The Energy Management System must not be run continuously at ambient temperatures of 55 °C

**DANGER!**

Danger of death by electric shock or fire

Live components carry potentially fatal voltages.

- The Fuse protection must not exceed 32 A. External current transformers should be used for higher currents.
- The eMS home must be connected with cables that are at least 10 mm² in cross section and no less than 1 m long.

Data cable recommendations

The following data cables are recommended for wiring up the bus interfaces in the Wallbox eMH1:

Designation	Cross section	Number
Cat5e	from at least 0.25 mm ²	1 cable for each connection between two wallboxes
Cat6	from at least 0.25 mm ²	

**WARNING!**

Selecting suitable data cables

Please note that these are recommendations only.

- The conductor cross-section must be adjusted according to the cable length by the specialist electrical contractor responsible for installation.
- The length of the data lines within the group installation must not exceed 100 m.

PIN allocation within the system

eMS home RS485 connector	eMH1 with spring terminal		eMH1 with RJ45 socket		eMH1 with RJ12 socket		Conductor colour*
	ABL bus allocation	Top view of terminal	PIN	Top view of socket	PIN	Top view of socket	
PIN 3	CONTROL A		1		3		Orange-white
PIN 2	CONTROL M		3 & 6		2 & 5		Green-White / Green
PIN 4	CONTROL B		2		4		Orange

* Colour coding according to EIA/TIA-T568B, variations possible

LED statuses**Status LED**

Colour	Status	Description
Orange	Illuminated (<10 s)	Device is starting
Green	Flashing slowly	
Green	Illuminated	Device ready-to-operate
Green	Flashing rapidly	Firmware update in progress

Status LED

Orange	Flashes 2x	Confirmation for resetting the network settings via the reset button or confirmation for resetting the device password (see "Functions of the reset button" on page 54)
Red	Illuminated	Restart eMS home (see "Functions of the reset button" on page 54) or contact Customer Service (see "Contact" on page 2)
Red	Flashing	

Network LED

Colour	Status	Description
–	Off	No connection
Green	Illuminated	Link
Green	Flashing	Activity

Serial bus LED

Colour	Status	Description
–	Off	No connection
Green	Flashing rapidly	Connection active
Green	Flashing slowly	Scanning active
Red	Illuminated	Error - overload at 5 V output
Orange	Flashing	Error - remote station not responding

Functions of the reset button**Restart eMS home**

- Use a pointed object to press and hold the reset button ① for just over 6 seconds. The eMS home will then restart.

Reset the password for the web interface

- Press the reset button ① as follows:
- 1 x long (between 3 and 5 seconds),
 - then within 1 s: 1 x short (0.5 second)

If the command was recognised correctly, the Status LED ② flashes orange twice. The password for the web interface is reset to the factory default (see Rating plate on page 7).

Reset network settings

- Press the reset button ① as follows:
- 1 x short (0.5 second),
 - then within 1 s: 1 x long (between 3 and 5 seconds).

Resetting the network settings activates DHCP, among other things. If the command was recognised correctly, the Status LED ② flashes orange twice.

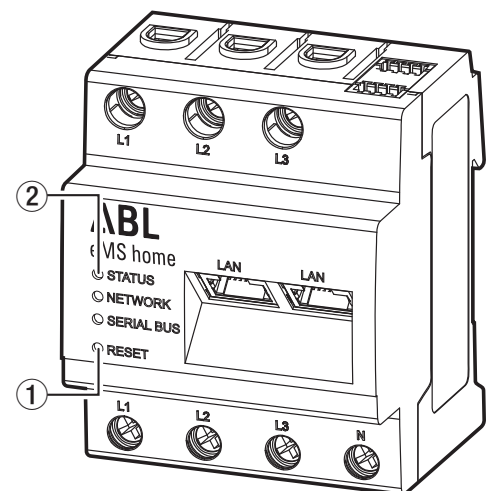

Licences

This product also contains open source software that was developed by third parties. This includes the GPL and LGPL licenses.

The licence texts containing the associated information can be found on the eMS home web interface in the footer under **Licences**.

Abbreviations

Abbreviation	Description
CSV	Comma-Separated Values
eMS	Energy Management System
FTP	File Transfer Protocol
GPL	General Public License
LGPL	Lesser General Public License
JSON	JavaScript Object Notation
MQTT	Message Queuing Telemetry Transport
PV	Photovoltaics
SFTP	Secure File Transfer Protocol
SMTP	Simple Mail Transfer Protocol
UPnP	Universal Plug and Play

Error codes

Some apps display error codes in the front end for warning or error messages. Based on these error codes, you can find further information on the type of malfunction from the following tables.

Error code	Error description and remedy
100	<p>The backup import operation could not be performed. Please first check the locally saved backup file selected and the corresponding password entered.</p> <p>If the backup file and password can be ruled out as the cause of the error, you will need to create a new backup file of the original device if possible. Make sure that the file extension and file type are not changed. You can now carry out the import process again.</p>
101	<p>An error occurred while creating a backup or importing a backup file. Please check the settings and try importing/exporting the backup file again.</p> <p>If the error persists, please create the system logs and contact Customer Service.</p>
102	<p>An error occurred while exporting the backup. The backup could not be created. Please check the selected settings and restart the device before trying again.</p> <p>If the error persists, please create the system logs and contact Customer Service.</p>
103	<p>An error occurred while importing the backup file. Please check the file extension and file size of the backup file. If possible, create the backup file again and repeat the process.</p> <p>If the error persists, please create the system logs and contact Customer Service.</p>
104	<p>The operation could not be performed because the backup file is too large. Please check the file extension and file size of the backup file. If possible, create the backup file again and repeat the process.</p> <p>If the error persists, please create the system logs and contact Customer Service.</p>

Error code	Error description and remedy
105	The operation could not be performed because the backup has an incorrect software version. Please update the device with the outdated software and create a backup again. Now repeat the import process.
106	The password you entered or the backup file you submitted is not valid. Please check the file used and the associated password. If this data is not available, please create a new backup file and password and repeat the process.
107	The firmware upgrade could not be performed. Please check that the firmware file used is the correct version. Alternatively, obtain the firmware from the manufacturer's website again and repeat the process.
108	The system is in a secured state. If available, please import a valid backup file. If this is not possible, please reset the device to the factory settings.
109	Synchronisation of the time server (NTP server) failed. Please check your Internet connection and server settings, then reload the page.
110	The error "The firmware could not be imported, an internal error has occurred" cannot be resolved by the user. <ul style="list-style-type: none"> ■ Please create the system logs and contact Customer Service.
111	The firmware used is not compatible with the device type. <ul style="list-style-type: none"> ■ Please create the system logs and contact Customer Service.
112	The firmware is not compatible with your product. Please compare the product name with the firmware used under Device Settings – System information. If the product specifications differ, you will need firmware that is compatible with the device. <ul style="list-style-type: none"> ■ If the error persists, please create the system logs and contact Customer Service.
113	The firmware could not be imported successfully. Please reload the firmware from the download area and try the update again. <ul style="list-style-type: none"> ■ If the error persists, please create the system logs and contact Customer Service.
114	The certificate used in the firmware is not compatible with your device. Please check the product name and the description of the firmware used under Device Settings – System information. If the product specifications differ, you will need firmware that is compatible with the device. <ul style="list-style-type: none"> ■ If the error persists, please create the system logs and contact Customer Service.

Error codes – Health Check app

Error code	Error description and remedy
150	The error "Application error occurred during file system check" cannot be resolved by the user. <ul style="list-style-type: none"> ■ Please create system logs and contact Customer Service
151	The error "Irreparable error detected in the file system" cannot be resolved by the user. <ul style="list-style-type: none"> ■ Please create system logs and contact Customer Service

Error codes – Data Storage app

Error code	Error description and remedy
200	The error "Error code 200: Writing CSV file failed" cannot be resolved by the user. <ul style="list-style-type: none"> ■ Please contact Customer Service.

Error code	Error description and remedy
201	The CSV file could not be exported via FTP/SFTP. Please check the FTP/SFTP configuration in the eMS home and the configuration of the FTP/SFTP server. <ul style="list-style-type: none"> ■ If the error persists, please create the system logs and contact Customer Service or the FTP provider.
202	The CSV file could not be exported via email. Please check the email configuration in the eMS home and the configuration of the SMTP server. <ul style="list-style-type: none"> ■ If the error persists, please create the system logs and contact Customer Service or the email provider.
203	The error "Error code 203: 1-minute aggregation failed" cannot be resolved by the user. <ul style="list-style-type: none"> ■ Please contact Customer Service.
204	The error "Error code 204: 15-minute aggregation failed" cannot be resolved by the user. <ul style="list-style-type: none"> ■ Please contact Customer Service.
205	The error "Error code 205: Daily aggregation failed" cannot be remedied by the user. <ul style="list-style-type: none"> ■ Please contact Customer Service.
206	The error "Error opening the database" cannot be resolved by the user. <ul style="list-style-type: none"> ■ Please contact Customer Service.

Error codes – Web application

Error code	Error description and remedy
500	The error "End of service life of flash memory" cannot be resolved by the user. <ul style="list-style-type: none"> ■ Please contact Customer Service.

OBIS system of indicators

OBIS codes are used for data transmission and differentiation of the various measurement data of a data source. OBIS stands for **Object Identification System** and is used for electronic data communication in the energy market. OBIS indicators consist of six value groups (A-F), which are combined to derive a specified value. They are represented in the form **A-B:C.D.E*F**.

The specific OBIS indicators used in eMS home are described in this appendix depending on the data source (see Appendix "OBIS system of indicators" on page 57). The basis is the OBIS system of indicators, version 2.0 (last updated 2 February 2009), which is based on DIN EN 62056-61:2007-06 and can be found at edi-energy.de.

The individual groups are explained below in the context of the eMS home.

Group A (medium)

A = 1 (electricity)

Group B (channel)

Used to distinguish between the three possible data sources:

- For smart meter values: B = 0

Group C (measured variable)

Key value of the resulting measured variable according to the OBIS system of indicators

Group D (measurement type)

Key value of the applied measurement type according to the OBIS system of indicators

Group E (tariff level)

Key value of the tariff, usually E = 0 (total)

Group F (previous value meter reading)

F = 255

Please note: The values of groups A and F are fixed, those of the remaining groups are variable.

Data Storage app – CSV export format

The columns of the CSV export file are described below. Initially, it contains 2 columns for timestamps and 130 columns for smart meters. After that, 20 columns are added for each configured sensor. After the sensors, 22 columns are added for each configured group. For each value (except meter values), the minimum and maximum values generated by the aggregation interval are also displayed.

Timestamps and smart meters

Description	OBIS code	Unit
Timestamp (YYYY-MM-DD HH:MM:SS)	–	–
UNIX timestamp	–	–
Active Power +	1-0:1.4.0*255	W
Active Power + min	1-0:1.3.0*255	W
Active Power + max	1-0:1.6.0*255	W
Active energy+	1-0:1.8.0*255	Wh
Active power-	1-0:2.4.0*255	W
Active power- min	1-0:2.3.0*255	W
Active power- max	1-0:2.6.0*255	W
Active energy-	1-0:2.8.0*255	Wh
Reactive power+	1-0:3.4.0*255	var
Reactive power+ min	1-0:3.3.0*255	var
Reactive power+ max	1-0:3.6.0*255	var
Reactive energy+	1-0:3.8.0*255	varh
Reactive power-	1-0:4.4.0*255	var
Reactive power- min	1-0:4.3.0*255	var
Reactive power- max	1-0:4.6.0*255	var
Reactive energy-	1-0:4.8.0*255	varh
Apparent power+	1-0:9.4.0*255	VA
Apparent power+ min	1-0:9.3.0*255	VA
Apparent power+ max	1-0:9.6.0*255	VA
Apparent energy+	1-0:9.8.0*255	vah
Apparent power-	1-0:10.4.0*255	VA
Apparent power- min	1-0:10.3.0*255	VA
Apparent power- max	1-0:10.6.0*255	VA

Description	OBIS code	Unit
Apparent energy-	1-0:10.8.0*255	vah
Power factor	1-0:13.4.0*255	none
Power factor min	1-0:13.3.0*255	none
Power factor max	1-0:13.6.0*255	none
Supply frequency	1-0:14.4.0*255	Hz
Supply frequency min	1-0:14.3.0*255	Hz
Supply frequency max	1-0:14.6.0*255	Hz
Active power+ (L1)	1-0:21.4.0*255	W
Active power+ (L1) min	1-0:21.3.0*255	W
Active power+ (L1) max	1-0:21.6.0*255	W
Active energy+ (L1)	1-0:21.8.0*255	Wh
Active power- (L1)	1-0:22.4.0*255	W
Active power- (L1) min	1-0:22.3.0*255	W
Active power- (L1) max	1-0:22.6.0*255	W
Active energy- (L1)	1-0:22.8.0*255	Wh
Reactive power+ (L1)	1-0:23.4.0*255	var
Reactive power+ (L1) min	1-0:23.3.0*255	var
Reactive power+ (L1) max	1-0:23.6.0*255	var
Reactive energy+ (L1)	1-0:23.8.0*255	varh
Reactive power- (L1)	1-0:24.4.0*255	var
Reactive power- (L1) min	1-0:24.3.0*255	var
Reactive power- (L1) max	1-0:24.6.0*255	var
Reactive energy- (L1)	1-0:24.8.0*255	varh
Apparent power+ (L1)	1-0:29.4.0*255	VA
Apparent power+ (L1) min	1-0:29.3.0*255	VA
Apparent power+ (L1) max	1-0:29.6.0*255	VA
Apparent energy+ (L1)	1-0:29.8.0*255	vah
Apparent power- (L1)	1-0:30.4.0*255	VA
Apparent power- (L1) min	1-0:30.3.0*255	VA
Apparent power- (L1) max	1-0:30.6.0*255	VA
Apparent energy- (L1)	1-0:30.8.0*255	vah
Current (L1)	1-0:31.4.0*255	A
Current (L1) min	1-0:31.3.0*255	A
Current (L1) max	1-0:31.6.0*255	A
Voltage (L1)	1-0:32.4.0*255	V

Description	OBIS code	Unit
Voltage (L1) min	1-0:32.3.0*255	V
Voltage (L1) max	1-0:32.6.0*255	V
Power factor (L1)	1-0:33.4.0*255	none
Power factor (L1) min	1-0:33.3.0*255	none
Power factor (L1) max	1-0:33.6.0*255	none
Active power+ (L2)	1-0:41.4.0*255	W
Active power+ (L2) min	1-0:41.3.0*255	W
Active power+ (L2) max	1-0:41.6.0*255	W
Active energy+ (L2)	1-0:41.8.0*255	Wh
Active power- (L2)	1-0:42.4.0*255	W
Active power- (L2) min	1-0:42.3.0*255	W
Active power- (L2) max	1-0:42.6.0*255	W
Active energy- (L2)	1-0:42.8.0*255	Wh
Reactive power+ (L2)	1-0:43.4.0*255	var
Reactive power+ (L2) min	1-0:43.3.0*255	var
Reactive power+ (L2) max	1-0:43.6.0*255	var
Reactive energy+ (L2)	1-0:43.8.0*255	varh
Reactive power- (L2)	1-0:44.4.0*255	var
Reactive power- (L2) min	1-0:44.3.0*255	var
Reactive power- (L2) max	1-0:44.6.0*255	var
Reactive energy- (L2)	1-0:44.8.0*255	varh
Apparent power+ (L2)	1-0:49.4.0*255	VA
Apparent power+ (L2) min	1-0:49.3.0*255	VA
Apparent power+ (L2) max	1-0:49.6.0*255	VA
Apparent energy+ (L2)	1-0:49.8.0*255	vah
Apparent power- (L2)	1-0:50.4.0*255	VA
Apparent power- (L2) min	1-0:50.3.0*255	VA
Apparent power- (L2) max	1-0:50.6.0*255	VA
Apparent energy- (L2)	1-0:50.8.0*255	vah
Current (L2)	1-0:51.4.0*255	A
Current (L2) min	1-0:51.3.0*255	A
Current (L2) max	1-0:51.6.0*255	A
Voltage (L2)	1-0:52.4.0*255	V
Voltage (L2) min	1-0:52.3.0*255	V
Voltage (L2) max	1-0:52.6.0*255	V

Description	OBIS code	Unit
Power factor (L2)	1-0:53.4.0*255	none
Power factor (L2) min	1-0:53.3.0*255	none
Power factor (L2) max	1-0:53.6.0*255	none
Active power+ (L3)	1-0:61.4.0*255	W
Active power+ (L3) min	1-0:61.3.0*255	W
Active power+ (L3) max	1-0:61.6.0*255	W
Active energy+ (L3)	1-0:61.8.0*255	Wh
Active power- (L3)	1-0:62.4.0*255	W
Active power- (L3) min	1-0:62.3.0*255	W
Active power- (L3) max	1-0:62.6.0*255	W
Active energy- (L3)	1-0:62.8.0*255	Wh
Reactive power+ (L3)	1-0:63.4.0*255	var
Reactive power+ (L3) min	1-0:63.3.0*255	var
Reactive power+ (L3) max	1-0:63.6.0*255	var
Reactive energy+ (L3)	1-0:63.8.0*255	varh
Reactive power- (L3)	1-0:64.4.0*255	var
Reactive power- (L3) min	1-0:64.3.0*255	var
Reactive power- (L3) max	1-0:64.6.0*255	var
Reactive energy- (L3)	1-0:64.8.0*255	varh
Apparent power+ (L3)	1-0:69.4.0*255	VA
Apparent power+ (L3) min	1-0:69.3.0*255	VA
Apparent power+ (L3) max	1-0:69.6.0*255	VA
Apparent energy+ (L3)	1-0:69.8.0*255	vah
Apparent power- (L3)	1-0:70.4.0*255	VA
Apparent power- (L3) min	1-0:70.3.0*255	VA
Apparent power- (L3) max	1-0:70.6.0*255	VA
Apparent energy- (L3)	1-0:70.8.0*255	vah
Current (L3)	1-0:71.4.0*255	A
Current (L3) min	1-0:71.3.0*255	A
Current (L3) max	1-0:71.6.0*255	A
Voltage (L3)	1-0:72.4.0*255	V
Voltage (L3) min	1-0:72.3.0*255	V
Voltage (L3) max	1-0:72.6.0*255	V
Power factor (L3)	1-0:73.4.0*255	none

Description	OBIS code	Unit
Power factor (L3) min	1-0:73.3.0*255	none
Power factor (L3) max	1-0:73.6.0*255	none

FAQs – Frequently Asked Questions

If you encounter problems during installation or operation of the eMS home, please read the following questions and answers before contacting ABL Customer Service.

My vehicle does not charge

- The mains connection is utilised to such an extent that another vehicle to be charged would lead to an overload. If sufficient capacity is available again at a later time, the charging process is started.
- To increase the stability of the system, a vehicle is not authorised for charging for several minutes after the charging process has been paused.
- In **Charging with surplus PV** mode, there may not be enough surplus for a vehicle to charge.

My vehicle charges in “Charging with surplus PV” mode, although there is currently not enough surplus

- After you have connected a vehicle, an initialisation process is started regardless of the current surplus if sufficient power is available at the mains connection. During the initialisation process, there may therefore be a brief mains draw.
- In the event of a drop in surplus (e.g. due to clouds), additional electricity is drawn from the grid for 5 minutes to stabilise the charging process. If after these 5 minutes there is still too little surplus to charge the vehicle, the charging process is paused.
- The surplus is summed over all phases of the mains connection. Depending on the number of phases used to charge the vehicle, this summed surplus is divided arithmetically among the phases of the connected vehicle.
Example: A single-phase charging vehicle is charged at a three-phase mains connection. The surplus from all three phases is added up and given to the single-phase vehicle.

The web interface is not accessible

- Please check the network topology. A network cable must be connected to the LAN interface of the eMS home, which on the other side is connected to the PC/laptop directly or via a router/switch.
- If the eMS home has been restarted (e.g. after a firmware update), it may take several minutes until the web interface is accessible again.
- The eMS home may have been assigned a new IP address by the DHCP server. Check the current IP address in your router or call up the network environment of your Windows computer (see note in the section “Log in to the eMS home” on page 21).

Problems during configuration with the ABL Configuration Software

- Make sure that the RS485 connector on the eMS home is disconnected when configuring the wallboxes.
- Please refer to the section “Troubleshooting” in the manual of the **ABL Configuration Software** (→ **ABL Configuration Software**).

Error when adding the wallboxes in the web interface (orange exclamation mark)

- Make sure that the added wallbox is supplied with power and that the RCD is in position I.
- Make sure that the wallbox is in **Controller/Extender** mode.
- When adding the wallboxes, make sure that the interface is selected in which you have plugged in the RS485 connector with the connected data cable (default: slot **B**).
- Make sure that the correct bus address of the wallbox has been selected (**Wallbox ID**).

Disposal notice

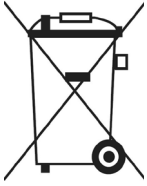

The crossed out trash can symbol indicates that electrical and electronic devices including accessories must be disposed of separately from household waste.

The materials are recyclable as marked. The reuse or recycling of materials, or other forms of repurposing of old devices make an important contribution towards protecting the environment.

Intellectual property & copyright

Copyright © 2022

Version 0301675_b, Last updated 18 July 2022

Software version: 3.0.0

All rights reserved.

- Any information contained in this manual may be changed without prior notice and does not represent any obligation on the part of the manufacturer.
- Illustrations in this manual may show designs different from the delivered product and do not represent any obligation on the part of the manufacturer.
- The manufacturer does not take responsibility for any loss and/or damage that occurs because of the data or possible misinformation contained in this manual.



ABL GmbH

Albert-Büttner-Straße 11
91207 Lauf an der Pegnitz
Germany



+49 (0) 9123 188-0



+49 (0) 9123 188-188



info@abl.de



www.ablmobility.de